

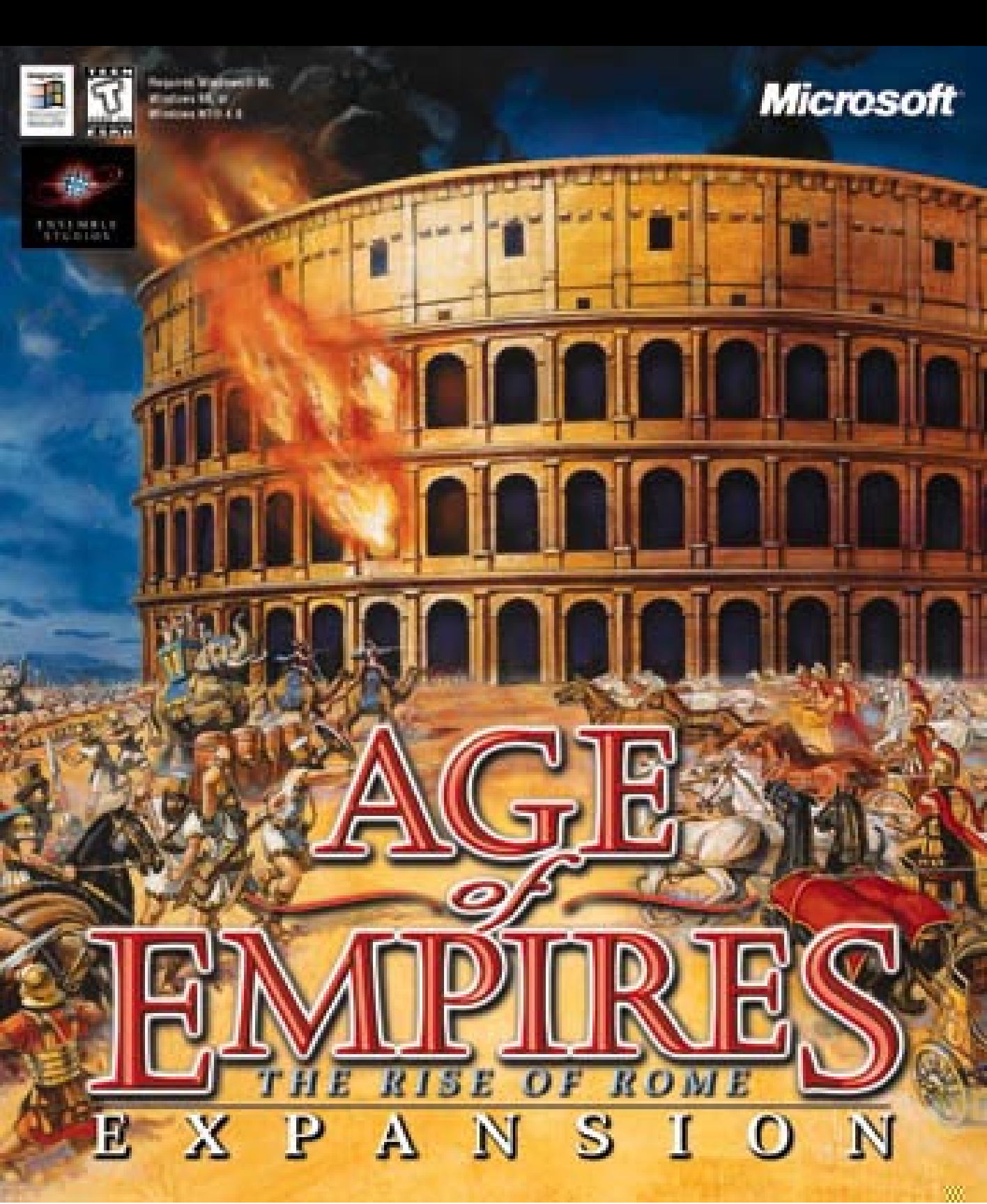

Requires Windows® 95,  
Windows 98, or  
Windows NT® 4.0

Microsoft



# AGE *of* EMPIRES

THE RISE OF ROME

## EXPANSION

The background of the entire page is a grayscale illustration of Roman legionaries. In the foreground, a legionary on the left holds a large, round shield with a central circular emblem and a laurel wreath. In the center, another legionary holds a sword and a rectangular shield with a central circular emblem and a laurel wreath. On the right, a legionary holds a large, rectangular shield with a central circular emblem and a laurel wreath. In the background, other legionaries are visible, some holding spears. The scene is set in a forest with tall, thin trees.

# AGE *of* EMPIRES

THE RISE OF ROME  
EXPANSION

## Contents

Chapter 1: Gameplay .....	2
Chapter 2: Units .....	4
Chapter 3: Technologies .....	7
Chapter 4: Civilizations .....	9
Appendix .....	14



# Chapter 1 Gameplay

## New features

Age of Empires Expansion includes these new features:

- Four new civilizations: Carthaginian, Macedonian, Palmyran, and Roman. For more information, see Chapter 4.
- Five new units: Armored Elephant, Camel Rider, Fire Galley, Scythe Chariot, and Slinger. For more information, see Chapter 2.
- Four new technologies: Logistics, Martyrdom, Medicine, and Tower Shield. For more information, see Chapter 3.
- Four new campaigns.
- New ability to queue the production of units. For more information, see Chapter 2.
- New Gigantic map size.
- New map types: Continental, Mediterranean, Hill Country, and Narrows.
- Double-clicking a unit selects all units of that type on the game screen.
- New Random civilization option so you don't know which civilization you're playing until the game starts.
- You can display the game settings (map type, map size, etc.) during a game by clicking the Menu button on the menu bar, and then clicking Scenario Instructions.
- When you hear a sound cue (such as an attack warning), you can press the HOME key or click the middle mouse button to go to the trouble spot. Pressing the key multiple times cycles through the location of the last five sound cues.

# Expansion changes

Age of Empires Expansion includes these changes. The changes are only in the expansion pack, not Age of Empires 1.0, 1.0A, or 1.0B.

- Stone Throwers, Catapults, and Heavy Catapults now receive a limited predictive firing benefit from Ballistics, based on the target unit's speed. All slow units in range are hit, some medium units are hit, and all fast units are missed.
- Persian civilization no longer has a farming penalty.
- Some random maps contain cliffs.
- Allied Town Centers are visible when you start an allied game.
- The population indicator and timer appear at the top of the game screen when you press F11.
- The hot key to build a Swordsman is now Z.
- The hot key to build a Scout is now T.
- If you select the Full Tech Tree option before starting a game, you cannot build Fire Galleys.
- In multiplayer games, there is now an in-game option to change the population limit using the Game Settings.
- Chat is automatically set to Allies Only in an allied multiplayer game.

Note: Age of Empires Expansion includes the online Help for Age of Empires 1.0. It has not been updated with the new features and changes in Age of Empires Expansion. Complete information about Age of Empires Expansion is in this manual.

## Installing

Age of Empires Gold installs both Age of Empires 1.0B and Age of Empires Expansion 1.0 on your computer.

To install (or uninstall) Age of Empires Gold

- ▶ Insert the Age of Empires Gold CD into the CD-ROM drive, and then follow the directions on the screen.

If Setup does not begin automatically, refer to the Readme file on the Age of Empires Gold CD.

## Starting

You must have the Age of Empires Gold CD in your CD-ROM drive to play single player games or use the scenario builder. If you do not have a CD, you can play only multiplayer games.

A multiplayer game requires the following number of CDs: 2–3 players (1 CD); 4–6 players (2 CDs); 7–8 players (3 CDs). You can connect only to multiplayer games created with the same Age of Empires version you are using. For example, if you are using Age of Empires Expansion, only Expansion games appear in the multiplayer games list.

To start Age of Empires Expansion

- ▶ Insert the Age of Empires Gold CD into the CD-ROM drive, click the Start button, point to Programs, point to Microsoft Games, point to Age of Empires Gold, and then click Age of Empires Expansion.

# Chapter 2 Units

Age of Empires Expansion includes five new units and the ability to queue the production of units. For costs and other attributes, see the Unit Attributes table in the Appendix. For information about which civilizations can build the units, see the technology trees in the Appendix.

## Queuing units

You can now queue the production of units. You cannot queue technology research.

To add units to a queue

- ▶ Click the building, and then click the button of the unit you want to build. For example, to train three Axemen, click the Barracks, and then click the Train Axeman button three times.  
The number of units in the queue is displayed on the unit button, and the cost of each unit is deducted from your resources immediately. You must have the resources to build a unit before you can add it to the queue.

To delete units from a queue

- ▶ Right-click the unit button. For example, to remove one Axeman from the queue, right-click the Train Axeman button once. To remove all units from the queue, click the Stop button.

If a building is queuing units, you cannot build other types of units there. For example, if you queue three Axemen at the Barracks, you cannot build other units there until all three Axemen are built (or you stop the queue). The population indicator (F11) flashes if you reach the population limit or do not have enough housing to build the next unit in the queue.

If your building is destroyed or converted while producing queued units, the resources for the units in the queue are returned to your stockpile (except for the unit currently in production).

## Armored Elephant



Age: Iron

Train at: Stable

Prerequisite: Iron Shield

Upgrade cost: 1000 food, 1200 gold

**Special:** Increased attack vs. walls and towers; +1 armor against missile weapons, Ballista, Helepolis; trample damage to adjacent enemy units; attack strength cannot be upgraded.

The Armored Elephant is an upgrade of the War Elephant. The Armored Elephant has Siegecraft, more attack strength, armor, and piercing armor.

Leather Armor, Scale Armor, and Chain Mail increase armor.

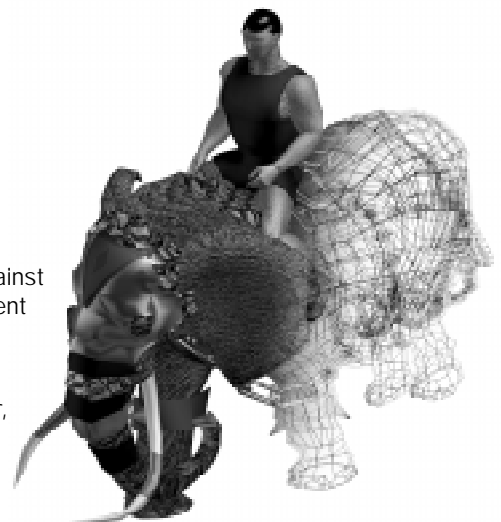

Armies using elephants in battle learned quickly that wounded animals could be as dangerous to friendly troops as they were to the enemy. One solution to this problem was to cover elephants partially with light armor that helped protect them from arrows and spears. Unwounded animals were much easier to control and direct against the enemy. Keeping the elephants under control and bringing them into contact with the enemy was critical. Only veteran troops would stand and fight against a determined charge by elephants. All others would rout when the elephants got close.

## Camel Rider



Age: Bronze

Train at: Stable

Special: Attack bonus against all cavalry, horse archers, and chariots.

The Camel Rider is used by desert civilizations to defend against cavalry attacks. Camel Riders do not receive a cavalry bonus against infantry.

Nobility increases hit points. Toolworking, Metalworking, and Metallurgy increase attack strength. Leather Armor, Scale Armor, and Chain Mail increase armor.

The camel was adopted for military use at a very early date, perhaps before the horse in the Middle East. Camels were particularly useful for moving quickly across the desert wastes and favored by small raiding parties. They were also used in battle by desert civilizations such as the Assyrians. Riders fought with spears and swords. Like light cavalry, they could take part in the pursuit of a beaten army. They were also useful against cavalry because horses were unaccustomed to the camels' odor and often refused to come near them.



## Fire Galley



Age: Iron

Train at: Dock

Prerequisite: War Galley

Special: Boats are twice as resistant to conversion as other units.

The Fire Galley is a short-range vessel used to defend against other ships. Fire Galleys are superior to Triremes in one-on-one combat. Fire Galleys take additional damage from Ballistas, Helepolis, Stone Throwers, Catapults, Heavy Catapults, Catapult Triremes, and Juggernauts, whose heavy artillery can shatter the Fire Galley's burning fire pots and set fire to the ship.

Alchemy increases attack strength.

Note: You cannot build Fire Galleys if you select the Full Tech Tree option before starting a game.

Because ships were built primarily of combustible materials (wood, cloth, hemp, and pitch), fire was a devastating weapon against them. Ancient mariners devised several ways to set enemy ships on fire. The simplest was to fire flaming arrows or ballista bolts on an enemy ship. Next most useful were flaming grenades, something like modern Molotov cocktails, filled with a combustible liquid like oil. Most intricate were flaming firepots suspended from the bow of a ship by a pole. When the pole was positioned over the deck of an enemy ship, the pot was dropped, shattering it and spreading burning liquid over the deck.

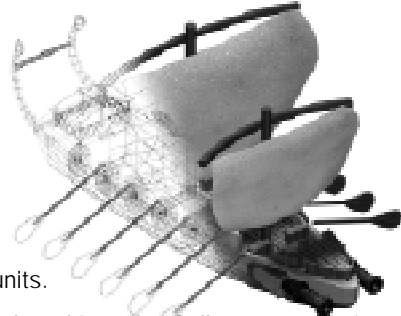

# Scythe Chariot



Age: Iron

Train at: Stable

Prerequisite: Nobility, Wheel

Upgrade cost: 1200 wood, 800 gold

Special: High resistance to conversion; double attack against Priests. Scythed wheels damage adjacent enemy units.

The Scythe Chariot is an upgrade of the Chariot. It has more hit points, more attack strength, and more armor.

Toolworking, Metalworking, and Metallurgy increase attack strength. Leather Armor, Scale Armor, and Chain Mail increase armor.

Chariots went out of favor by the beginning of the last millennium BC in favor of cavalry. But they did not disappear completely. Some armies continued to use them and they remained a symbol of prestige. To make chariots more effective and fearsome, scythe blades were attached to the axles. As the chariot moved, the blades rotated through the air. A foot soldier facing an oncoming Scythe Chariot faced the prospect of being ridden down by the horse, shot by an arrow, stabbed by the soldier on board, or hacked by the blades. This could be a terrifying weapon against broken troops trying to flee. Against steady veteran troops, however, the Scythe Chariot was still a chariot with inherent weaknesses. If the horses could be wounded, the chariot faltered. The Persians attempted to use Scythe Chariots against Alexander the Great, but the weapon made little impression on the disciplined phalanxes.



# Slinger



Age: Tool

Train at: Barracks

Special: +2 attack against archers; +2 armor against missile weapons, Ballista, Helepolis; increased attack against walls and towers.

The Slinger is an infantry unit used to defend against early archer and Watch Tower attacks.

Bronze Shield, Iron Shield, and Tower Shield increase piercing armor. Alchemy increases attack strength. Stone Mining and Siegecraft increase attack strength and range.

Note: Slingers do not get armor upgrades from Leather Armor, Scale Armor, and Chain Mail.

Slingers were light troops who threw stones at the enemy, causing casualties and disrupting formations. A barrage of heavy stones could cause wounds and bone fractures. The stone was held in a cloth sling and swung in a vertical loop to build centrifugal force. One end of the sling was released, launching the stone. Slingers were an alternative to archers and javelin men. They threw stones of different weights, depending on the range to the target. Roman art shows slingers throwing rocks the size of grapefruit, probably at short range. Specially shaped stones could be thrown accurately to a respectable distance. The best known slinger of antiquity was David, who slew the Philistine champion Goliath in single combat with a shot to the head. A contingent of Rhodesian slingers were part of the 10,000-man mercenary force whose march home from Persia is described by Xenophon in his book *Anabasis*.



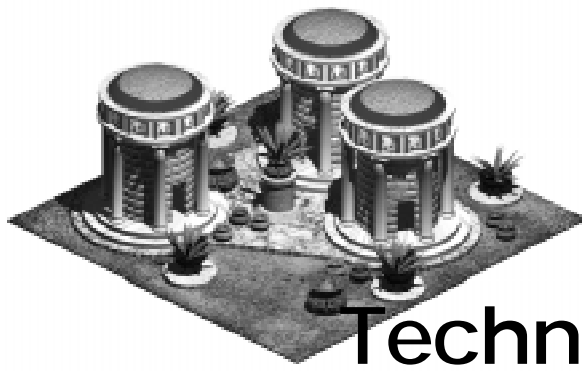

## Chapter 3 Technologies

Age of Empires Expansion includes four new technologies. For information about all technologies in the game, see the Technology Costs & Benefits table in the Appendix. For information about which civilizations can research which technologies, see the technology trees in the Appendix.

### Logistics



Age: Bronze

Research at: Government Center

**Benefit:** Barracks units only count as half a unit toward your population, so you can essentially exceed the population limit by training Barracks units. For example, if the population limit is 50 and you build 20 normal units, you can train 60 Barracks units (for a total of 80 units) without exceeding the population limit.

The science of supplying armies on the march was called logistics. The Assyrians were the first great army to employ logistics consistently, and this allowed them to operate regularly at great distances from their home bases. Armies on campaign needed food, forage for animals, equipment, armor, and weapons. In most cases, food was acquired from the countryside through which the army was moving. But if an army paused to besiege a town, it exhausted local supplies quickly. Food and forage had to be brought in or the army was forced to retire. The tools of logistics were supply wagons, pack animals, depots, and troops to keep the roads open. The great conquerors of antiquity mastered logistics.

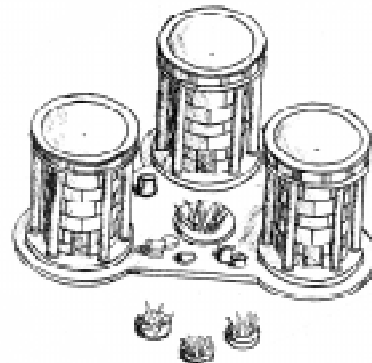
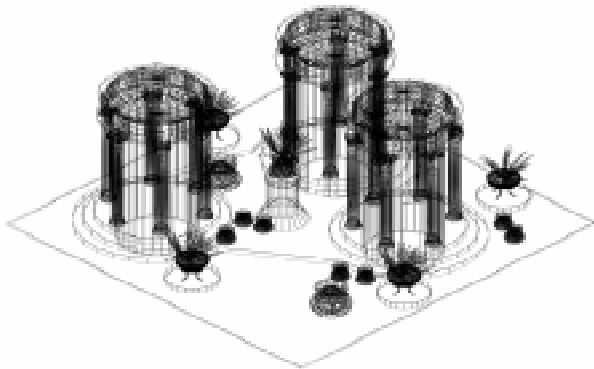



# Martyrdom



Age: Iron

Research at: Temple

Benefit: Lets you instantly convert an enemy unit by sacrificing one of your Priests. You cannot use Martyrdom to convert an enemy Priest.

To convert a unit using Martyrdom

- 1 Click a Priest, and then right-click the enemy unit to convert.
- 2 After the Priest starts converting, press DELETE. The priest is killed and the unit is instantly converted.

Fervent believers who refused to renounce their religion at the risk of death were called martyrs. Witnessing the death of a martyr had a powerful effect on anyone of weak faith. The cause of Christianity, for example, was strengthened by the spectacle of believers who willingly chose death over conversion to a pagan religion then accepted by the Romans.

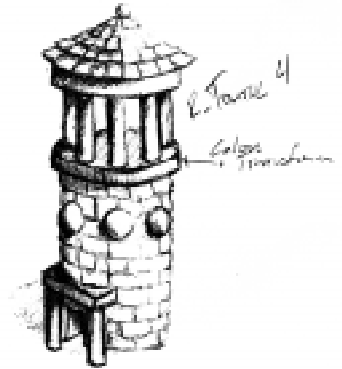

# Medicine



Age: Iron

Research at: Temple

Benefit: Increases Priest healing rate.

Through trial and error, humans learned that certain herbs and plant products possessed medicinal qualities. The invention of writing made it possible to record this knowledge and pass it on to following generations by a method other than oral transmission. The science of medicine progressed gradually, improving the quality and length of life.

# Tower Shield



Age: Iron

Research at: Storage Pit

Benefit: +1 infantry armor against Ballista, Helepolis, and missile weapons.

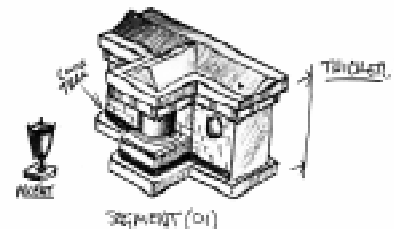

The Romans adopted a tall rectangular shield that gave them advantages in battle when used properly. The size of the shield protected more of the body. The Romans fought in tight rectangular formations of approximately 100 men called maniples. The shields of the men in the maniple presented a continuous front, or shield wall, which protected them greatly from missile fire. They developed a formation variant called the Testudo (or turtle). In this formation, the shields covered all four sides and the heads of the men, allowing them to advance under missile fire. This was useful when advancing toward a gap in an enemy wall.



## Chapter 4 Civilizations

Age of Empires Expansion includes four new civilizations. Each civilization has unique strengths and weaknesses and can research different units and technologies. For information about the special attributes of each civilization, see the Civilization Attributes table in the Appendix. For information about the units and technologies each civilization can research, see the technology trees in the Appendix.

# Carthaginian civilization

(800 BC to 146 BC)

During the beginning of the last millennium BC, the Phoenicians began establishing colonies around the Mediterranean to compete with the Greeks for trade. The most important Phoenician colony was Carthage. It was founded around 800 BC near modern Tunis in North Africa.

Although the home cities in Phoenicia were repeatedly conquered and subjugated, the colony of Carthage prospered and expanded to become one of the great powers of the Western Mediterranean.

True to their Phoenician heritage, the Carthaginians became great seafarers, traders, and colonizers. There is some evidence that they circumnavigated Africa and very questionable evidence that they reached the Americas. They capitalized on the trade of Iberian silver and British tin. Carthaginian settlements spread along the North African coast, into western Sicily, Sardinia, Corsica, Minorca, and much of Spain (modern Cartagena in Spain was called Carthago Nova, or New Carthage) and the Portuguese Atlantic coast (with several trade posts and support harbors). During the fifth and fourth centuries BC they fought with the Greeks for trade and colonies, especially in Sicily. In the third century, they began a titanic clash with the rising power of Rome.

The Punic Wars between Rome and Carthage were fought to decide which power would dominate the Western Mediterranean. The first war (264–241 BC) was fought over Sicily. The Romans were not a naval power but built fleets from scratch based on the plans of a captured ship. Their first two fleets defeated Carthaginian fleets but were in turn lost to storms. Their third fleet completed the defeat of the Carthaginians at sea. The Carthaginians were forced out of Sicily, and lost Corsica and Sardinia as well.

The Second Punic War (218–201 BC) was a temporary improvement of Carthaginian fortunes and a near victory. The war was triggered by the great general Hannibal who marched out of modern Spain, across modern France, and into modern Italy across the Alps with a large army, including war elephants. In a brilliant campaign of 16 years, Hannibal defeated the Romans at every turn, although he lacked the critical strength to take Rome itself and end the war. Unable to defeat Hannibal's army in Italy, the Romans attacked the Carthaginians first in Spain and then in North Africa. Hannibal was called out of Italy to defend the homeland. At the decisive battle at Zama, the Romans destroyed the Carthaginian army.

Carthage was forced to give up its overseas possessions, pay a large indemnity, reduce its fleet, and become subservient to Rome. By 150 BC the city had recovered and was seen again as a threat. When the Carthaginians attacked Numidia, a Roman ally, the Romans responded by attacking Carthage once more. This time the city was destroyed utterly and its power broken forever. A symbolic furrow was plowed through the city and sown with salt to show that the city would not be allowed to revive.

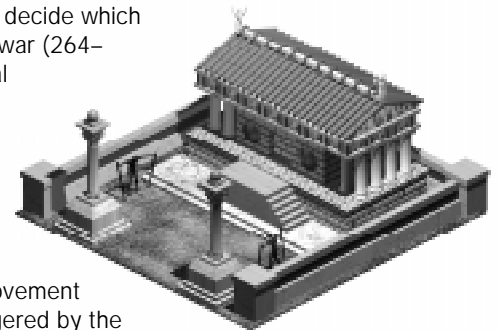

# Macedonian civilization

(323 BC to 146 BC)

The Macedonians were a Greek people that populated the south central Balkan Peninsula. In 338 BC, King Philip II of Macedonia conquered the Greek city-states. Philip's son, Alexander the Great, conquered nearly every civilization from Egypt to India, building a huge empire in which culture and art flourished. After Alexander's death in 323 BC, his empire went through many years of turmoil as his senior generals and family members vied for control. By 301 BC, Alexander's

mother, wife, son, and half brother had all been murdered. Following the battle of Ipsus that year in Asia Minor, the empire was divided into four kingdoms—Macedonia, Thrace, Egypt, and Persia. Although Egypt and Persia both initially claimed Syria, Persia annexed it by 281 BC. In 277 BC, Antigonos Gonatas (a descendent of Antigonos, one of Alexander's generals) became king of the Greek Kingdom of Macedonia and established the ruling Antigonid dynasty, which reigned until its conquest by the Romans. Together with Syria and Egypt, Macedonia became one of the three great kingdoms of the Hellenistic world. Macedonia's attempt to expand its territories met opposition from Pyrrhus and the confederation of the city-states of central and southern Greece. (Athens bribed its way out of the confederation and became a neutral state, but never regained its past prominence.)

During the 3rd century BC, Pyrrhus came to the aid of the Greek colonies in southern Italy and Sicily that were fighting the Romans in Italy. The early victories by Pyrrhus were so costly and had so little effect (thus the expression, "Pyrrhic victories") that the Greeks were forced to withdraw by 275 BC. During the Second Punic War the Greeks actively aided Hannibal against the Romans. In this same period, the Greeks fought the Romans, who had invaded Illyria (northeast Adriatic coast from modern north Albania to Croatia) to put an end to piracy in the Adriatic.



mother, wife, son, and half brother had all been murdered. Following the battle of Ipsus that year in Asia Minor, the empire was divided into four kingdoms—Macedonia, Thrace, Egypt, and Persia. Although Egypt and Persia both initially claimed Syria, Persia annexed it by 281 BC. In 277 BC, Antigonos Gonatas (a descendent of Antigonos, one of Alexander's generals) became king of the Greek Kingdom of Macedonia and established the ruling Antigonid dynasty, which reigned until its conquest by the Romans. Together with Syria and Egypt, Macedonia became one of the three great kingdoms of the Hellenistic world. Macedonia's attempt to expand its territories met opposition from Pyrrhus and the confederation of the city-states of central and southern Greece. (Athens bribed its way out of the confederation and became a neutral state, but never regained its past prominence.)

During the 3rd century BC, Pyrrhus came to the aid of the Greek colonies in southern Italy and Sicily that were fighting the Romans in Italy. The early victories by Pyrrhus were so costly and had so little effect (thus the expression, "Pyrrhic victories") that the Greeks were forced to withdraw by 275 BC. During the Second Punic War the Greeks actively aided Hannibal against the Romans. In this same period, the Greeks fought the Romans, who had invaded Illyria (northeast Adriatic coast from modern north Albania to Croatia) to put an end to piracy in the Adriatic.

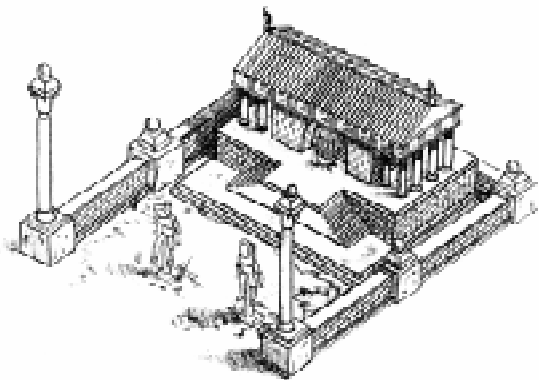

By 202 BC, the kingdom of Macedonia was struggling to maintain control of the city-states of the Greek Peninsula, which were joining together in rebellion. A small Roman army came to their aid and, by 196 BC, defeated the Macedonian army. Macedonia's power revived and the Romans invaded again in 172 BC, defeated the kingdom of Macedonia at the battle of Pydna in 168 BC, and removed the Antigonids from power. The Romans attempted to leave the other Greek city-states on their own, but the kingdom of Macedonia took up arms again. The Romans invaded in 149 BC and made the kingdom of Macedonia a Roman province. Roman patience with the other Greek city-states was exhausted by unrest in Corinth in

147 BC, so they besieged and sacked that city in 146 BC. As a lesson to the other city-states, the citizens of Corinth were sold into slavery, the buildings were torn down, and anything of value was shipped home to Rome.

# Palmyran civilization

(64 BC to 273 AD)

Following the collapse of the Seleucid empire in 64 BC (one of the vestiges of Alexander's empire), a no-man's land existed in the Middle East between the Roman empire to the west and the Parthian empire to the east. The people of Tadmor, a desert city located at an oasis on the east-west trade route, established a desert police force that protected the trade between Damascus and the Euphrates River. They grew rich on this trade and their city became known to the Romans as Palmyra (place of palms). Around 17 AD Palmyra became part of Roman Syria while retaining much independence and its desert army. In 129 Palmyra was granted the status of a free city and later was made a Roman colony.

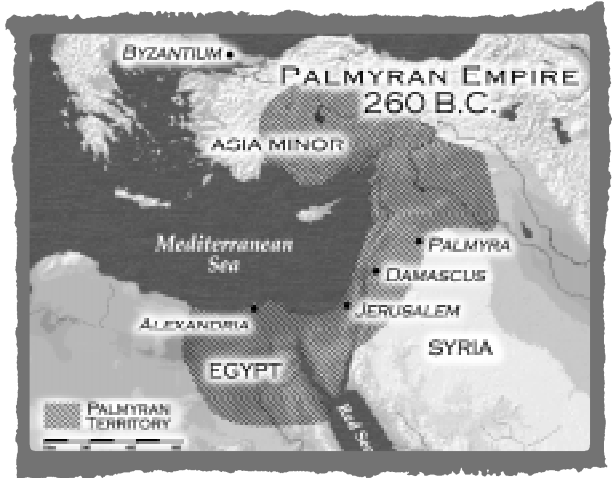

After the Persians defeated and captured the Roman emperor Valerian in 260, a Palmyran nobleman was made Dux Orientis (duke, or warlord, of the East—almost a co-emperor) and given Roman support. The Palmyran army defeated the Persians (capturing their capital at Ctesiphon on two occasions) and reconquered Mesopotamia. Following the suspicious murder of the Dux Orientis in 267, his wife Zenobia took the throne and claimed the title of Augustus for her infant son. The Romans were suspicious of these changes but an army they sent east was defeated by Zenobia, who was a competent war leader. The Palmyrans then occupied Egypt and pushed the Goths back out of Asia Minor. By this time the Palmyran empire stretched from Asia Minor to Mesopotamia to Egypt. Its army consisted mainly of archers, horse archers, and heavy cavalry.

The Romans could not ignore the revolt of the Palmyrans and the loss of the grain supplies from Egypt. One army was dispatched to Egypt to reestablish control there. The Emperor Aurelius (an ex-cavalry officer) led a second army into Syria and defeated the Palmyrans twice, at Antioch and Emesa. Roman light cavalry bested the Palmyran cataphracts. Palmyra was besieged and surrendered. Queen Zenobia was caught trying to flee but was allowed to retire into exile after being paraded through the streets of Rome. Palmyra revolted once more after the emperor departed, massacring the Roman garrison. The legions returned quickly and sacked the city. It continued to exist for many more centuries but never returned to prominence.

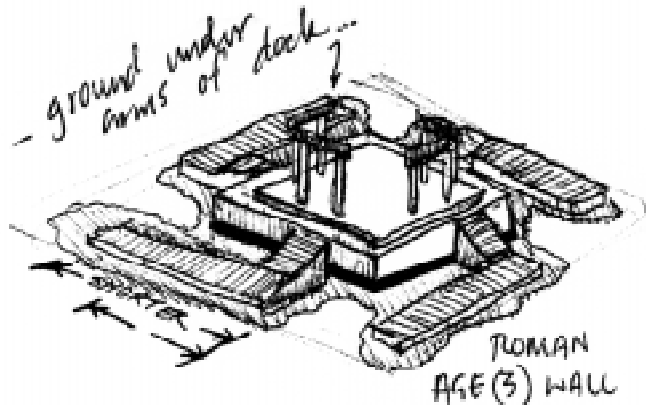

# Roman civilization

(750 BC to 476 AD)

The Romans began as a small tribe living in modern Italy but expanded to create the largest and longest lasting empire of antiquity. They were a hardy and industrious people who survived in a violent world mainly by creating a powerful army. The Roman Army went through many changes over the thousand years of its existence and failed eventually to defend the empire, but in general it was consistently superior to opponents from all corners of the world. The empire expanded on the strength of the ruthless and aggressive Roman legions, and consolidated through benign administration and public works on an unprecedented scale.

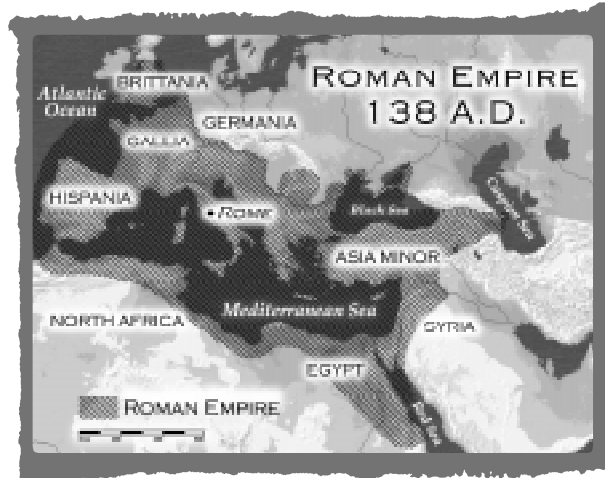

The people who became the Romans migrated from northern Europe and settled on the plains south of the Tiber River. They established towns on the seven hills near the river. These towns eventually merged to form their capital city of Rome. As first a republic and then an empire, Rome began expanding after 400 BC and eventually controlled the entire Mediterranean coastline, Europe west of the Rhine and south of the Danube, Egypt, Palestine, Syria, Asia Minor, and modern England.

The Roman Empire in the West ceased to exist in 476 AD, although it was gone for practical purposes many decades earlier. The proximate cause of the collapse was invasion across the Rhine and Danube Rivers by Germanic settlers. Many underlying causes for the collapse have been suggested. The adoption of Christianity and preoccupation with the afterlife instead of practical matters on Earth was one. The increasing inability to administer the large empire was another. Taxes were required after the second century to support the large army and this caused unrest and revolt in the provinces. The slave economy went into decline because slaves became sparse when conquests ceased after the second century. The empire failed to industrialize because of its dependence on slavery. Plague took a heavy toll on the population and trade declined thereafter. The army declined in quality because mercenaries had to replace citizens that avoided service as soldiers and officers. Repeated turmoil and civil war over succession to the throne sapped the strength of the legions and brought barbarian contingents into the army.

The legacy of the Romans was broad and far-reaching. It includes the transmission of much ancient culture to the modern age, especially Greek art and literature. The Romans began urbanization of Europe. In addition to Rome, they founded Paris, London, Lyons, Bordeaux, Cologne, Toledo, and Milan. Modern railway gauges trace back to wagon ruts in Roman mines. The Romans excelled at engineering and construction, and first used the arch, the dome, and concrete. A few of their famous roads, bridges, and aqueducts are still in use. The Latin language influenced the later development of the French, Spanish, Italian, Portuguese, and Romanian languages. Roman law was codified and updated by the Byzantines and is the basis of law for most European countries today.

ROMAN  
AGE (3)  
STORAGE PIT

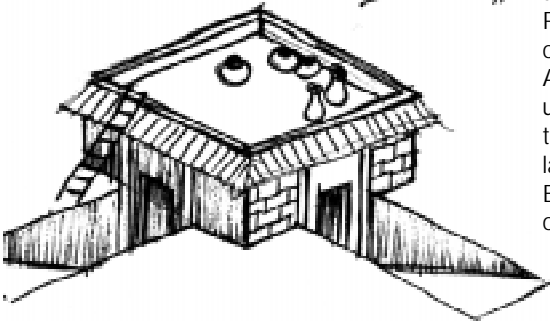

# Appendix

## Civilization Attributes

Civilization	Attributes
<b>Ancient Choson</b>	<ul style="list-style-type: none"><li>• Long Swordsman and Legion +80 hit points.</li><li>• Towers +2 range.</li><li>• Priests cost 30% less.</li></ul>
<b>Assyrian</b>	<ul style="list-style-type: none"><li>• Archery Range units have increased fire rate. (Value in game remains the same as Age of Empires 1.0; changes occurred after the original documentation was printed.)</li><li>• Villagers 30% faster.</li></ul>
<b>Babylonian</b>	<ul style="list-style-type: none"><li>• Wall and tower hit points doubled.</li><li>• Priest rejuvenation rate 30% faster.</li><li>• +30% stone mining.</li></ul>
<b>Carthaginian (new)</b>	<ul style="list-style-type: none"><li>• Transports 30% faster.</li><li>• Fire Galley +25% attack.</li><li>• Academy units and all elephant units +25% hit points.</li></ul>
<b>Egyptian</b>	<ul style="list-style-type: none"><li>• +20% gold mining.</li><li>• Chariot, Scythe Chariot, and Chariot Archer +33% hit points.</li><li>• Priest +3 range.</li></ul>
<b>Greek</b>	<ul style="list-style-type: none"><li>• Hoplite, Phalanx, and Centurion 30% faster.</li><li>• War ships 30% faster.</li></ul>
<b>Hittite</b>	<ul style="list-style-type: none"><li>• Stone Thrower, Catapult, and Heavy Catapult hit points doubled.</li><li>• Archery Range units +1 attack.</li><li>• War ships +4 range (except Fire Galley).</li></ul>
<b>Macedonian (new)</b>	<ul style="list-style-type: none"><li>• Academy units +2 armor vs. Slinger, Ballista, Helepolis, missile weapons.</li><li>• Units with no range +2 line of sight.</li><li>• Siege Workshop units cost 50% less.</li><li>• Units 4 times more resistant to conversion.</li></ul>
<b>Minoan</b>	<ul style="list-style-type: none"><li>• Ships cost 30% less.</li><li>• Composite Bowman +2 range.</li><li>• Farm production +25%.</li></ul>
<b>Palmyran (new)</b>	<ul style="list-style-type: none"><li>• Free tribute.</li><li>• Gold per trade trip doubled.</li><li>• Villagers cost 50% more, have armor, and work 20% faster.</li><li>• Camel Riders 25% faster.</li></ul>
<b>Persian</b>	<ul style="list-style-type: none"><li>• +30% hunting.</li><li>• War Elephant, Armored Elephant, and Elephant Archer 50% faster.</li><li>• Trireme +50% fire rate.</li></ul>
<b>Phoenician</b>	<ul style="list-style-type: none"><li>• War Elephant, Armored Elephant, and Elephant Archer cost 25% less.</li><li>• +30% woodcutting.</li><li>• Catapult Trireme and Juggernaught +65% fire rate.</li></ul>
<b>Roman (new)</b>	<ul style="list-style-type: none"><li>• Buildings cost 15% less, except towers, walls and Wonders.</li><li>• Towers cost 50% less.</li><li>• Swordsmen attack 33% faster.</li></ul>
<b>Shang</b>	<ul style="list-style-type: none"><li>• Villagers cost 30% less.</li><li>• Wall hit points doubled.</li></ul>
<b>Sumerian</b>	<ul style="list-style-type: none"><li>• Villagers +15 hit points.</li><li>• Stone Thrower, Catapult, Heavy Catapult +50% fire rate.</li><li>• Farm production doubled.</li></ul>
<b>Yamato</b>	<ul style="list-style-type: none"><li>• Horse archers, Scout, Cavalry, Heavy Cavalry, Cataphract cost 25% less.</li><li>• Villagers 30% faster.</li><li>• Ships +30% hit points.</li></ul>

Siege weapons/siege ships: Stone Thrower, catapults, Ballista, Helepolis, Catapult TIREME, Juggernaught.

Missile weapons: Archery Range units, towers, Scout Ship, War Galley, TIREME.

Hand-to-hand units: Barracks, Academy, Stable units (except War Elephant and Armored Elephant).

# Technology Costs & Benefits

Storage Pit	Toolworking	Tool	100F	+2 attack for hand-to-hand units.
	Metalworking	Bronze	200F, 120G	+2 attack for hand-to-hand units.
	Metallurgy	Iron	300F, 180G	+3 attack for hand-to-hand units. Required to upgrade to Cataphract.
	Bronze Shield	Bronze	150F, 180G	+1 infantry armor vs. Slinger, Ballista, Helepolis, and missile weapons.
	Iron Shield	Iron	200F, 320G	Same as above. Required for Armored Elephant.
	Tower Shield (new)	Iron	250F, 400G	+1 infantry armor vs. Slinger, Ballista, Helepolis, and missile weapons.
	Leather Armor Archers	Tool	100F	+2 armor for Archery Range units.
	Scale Armor Archers	Bronze	125F, 50G	+2 armor for Archery Range units.
	Chain Mail Archers	Iron	150F, 100G	+2 armor for Archery Range units. Required for Heavy Horse Archer.
	Leather Armor Cavalry	Tool	125F	+2 armor for Stable units.
	Scale Armor Cavalry	Bronze	150F, 50G	+2 armor for Stable units.
	Chain Mail Cavalry	Iron	175F, 100G	+2 armor for Stable units.
	Leather Armor Infantry	Tool	75F	+2 armor for Barracks and Academy units.
	Scale Armor Infantry	Bronze	100F, 50G	+2 armor for Barracks and Academy units.
Chain Mail Infantry	Iron	125F, 100G	+2 armor for Barracks and Academy units.	
Government Center	Architecture	Bronze	150F, 175W	-33% construction time and +20% hit points for buildings and walls.
	Nobility	Bronze	175F, 120G	+15% hit points for cavalry units, Camel Rider, Chariot, Scythe Chariot, Chariot Archer, Horse Archer, Heavy Horse Archer. Required for Scythe Chariot.
	Writing	Bronze	200F, 75G	Allies share exploration.
	Logistics (new)	Bronze	180F, 100G	Barracks units count as 1/2 unit toward population limit.
	Aristocracy	Iron	175F, 150G	Academy units 25% faster. Required to upgrade to Centurion.
	Alchemy	Iron	250F, 200G	+1 attack for Slinger, siege weapons and missile weapons. +6 Fire Galley attack. +2 Ballista/Helepolis attack. (Benefit increased for Expansion.)
	Ballistics	Iron	200F, 50G	Increases the accuracy of siege/missile weapons. Required for Ballista Tower.
	Engineering	Iron	200F, 100W	+2 range for siege weapons. Required to upgrade to Juggernaught.
Market	Woodworking	Tool	120F, 75W	+1 range for missile weapons. +2 woodcutting.
	Artisanship	Bronze	170F, 150W	+1 range for missile weapons. +2 woodcutting.
	Craftsmanship	Iron	240F, 200W	+1 range for missile weapons. +2 woodcutting. Required for Helepolis.
	Stone mining	Tool	100F, 50S	+3 stone mining. +1 attack and range for Slingers.
	Siegecraft	Iron	190F, 100S	+3 stone mining. Villagers can destroy walls, towers. Required to upgrade to Heavy Catapult. +1 attack and range for Slingers.
	Gold Mining	Tool	120F, 100W	+3 gold mining.
	Coinage	Iron	200F, 100G	+25% gold mine productivity. Free tribute.
	Domestication	Tool	200F, 50W	+75 food production for Farms.
	Plow	Bronze	250F, 75W	+75 food production for Farms.
	Irrigation	Iron	300F, 100W	+75 food production for Farms.
Wheel	Bronze	175F, 75W	Villagers 30% faster. Required to build Chariot, Scythe Chariot, and Chariot Archer.	
Temple	Astrology	Bronze	150G	Conversion 30% more effective.
	Mysticism	Bronze	120G	Priest hit points doubled.
	Polytheism	Bronze	120G	Priest moves 40% faster.
	Fanaticism	Iron	150G	Priest rejuvenation 50% faster.
	Monotheism	Iron	350G	Priest converts enemy Priests and buildings (except Town Center and Wonder).
	Afterlife	Iron	275G	+3 Priest conversion range.
	Jihad	Iron	120G	Increases Villager attack, speed, and hit points; decreases gathering efficiency.
	Martyrdom (new)	Iron	600G	Sacrifice Priest to instantly convert enemy unit (except Priest).
	Medicine (new)	Iron	150G	Increases Priest healing rate.
Town Center	Tool Age		500F	Allows all Tool Age buildings, military units, and technologies to be researched.
	Bronze Age		800F	Allows all Bronze Age buildings, military units, and technologies to be researched.
	Iron Age		1000F, 800G	Allows all Iron Age buildings, military units, and technologies to be researched.



# Unit Attributes

Speed: S=slow, M=medium, F=fast  
 Cost: F=food, W=wood, S=stone, G=gold

	Cost	Hit Pts	Attack	Armor	Range	Speed	Special	
INFANTRY	Villager	50F	25	3	—	M		
	Priest	125G	25	—	10	S		
	Clubman	50F	40	3	—	M		
	Axeman	50F	50	5	—	M		
	Slinger (new)	40F, 10S	25	2	—	4	M	+2 attack vs. archers. +2 armor vs. missile weapons, Ballista, Helepolis; increased attack vs. walls and towers.
	Short Swordsman	35F, 15G	60	7	1	—	M	
	Broad Swordsman	35F, 15G	70	9	1	—	M	
	Long Swordsman	35F, 15G	80	11	2	—	M	
	Legion	35F, 15G	160	13	2	—	M	
	Hoplite	60F, 40G	120	17	5	—	S	
Phalanx	60F, 40G	120	20	7	—	S		
Centurion	60F, 40G	160	30	8	—	S		
ARCHERS	Bowman	40F, 20W	35	3	0	5	M	
	Improved Bowman	40F, 20G	40	4	0	6	M	
	Composite Bowman	40F, 20G	45	5	0	7	M	
	Chariot Archer	40F, 70W	70	4	0	7	F	High resistance to conversion; triple attack vs. Priest.
	Elephant Archer	180F, 60G	600	5	0	7	S	
	Horse Archer	50F, 70G	60	7	0	7	F	+2 armor vs. missile weapons, Ballista, Helepolis.
	Heavy Horse Archer	50F, 70G	90	8	0	7	F	+2 armor vs. missile weapons, Ballista, Helepolis.
CAVALRY	Scout	100F	60	3	0	—	F	
	Camel Rider (new)	70F, 60G	125	6	—	—	F	+8 attack vs. cavalry and horse archers; +4 attack vs. chariots.
	Chariot	40F, 60W	100	7	0	—	F	High resistance to conversion; double attack vs. Priest.
	Scythe Chariot (new)	40F, 60W	120	9	2	—	F	Same as above. Wheels damage adjacent units.
	Cavalry	70F, 80G	150	8	0	—	F	+5 attack vs. Barracks units (except Slinger).
	Heavy Cavalry	70F, 80G	150	10	1	—	F	Same as above. +1 armor vs. missile weapons, Ballista, Helepolis.
	Cataphract	70F, 80G	180	12	3	—	F	Same as above.
	War Elephant	170F, 40G	600	15	0	—	S	Trample damage to adjacent units; attack strength not upgradable.
Armored Elephant (new)	170F, 40G	600	18	2	—	S	Same as above. Increased attack vs. walls and towers; +1 armor vs. missile weapons, Ballista, Helepolis.	
SIEGE WEAPONS	Stone Thrower	180W, 80G	75	50	—	10	S	Fire rate once/5 sec; small damage area; minimum range 2.
	Catapult	180W, 80G	75	60	—	12	S	Fire rate once/5 sec; medium damage area; minimum range 2.
	Heavy Catapult	180W, 80G	150	60	—	13	S	Fire rate once/5 sec; large damage area; minimum range 2.
	Ballista	100W, 80G	55	40	—	9	S	Fire rate once/3 sec; minimum range 3.
	Helepolis	100W, 80G	55	40	—	10	S	Fire rate once/1.5 sec; minimum range 3.
BOATS	Fishing Boat	50W	45	—	—	—	M	
	Fishing Ship	50W	75	—	—	—	F	
	Trade Boat	100W	200	—	—	—	F	
	Merchant Ship	100W	250	—	—	—	F	
	Light Transport	150W	150	—	—	—	M	
	Heavy Transport	150W	200	—	—	—	F	
	Scout Ship	135W	120	5	—	5	F	
	War Galley	135W	160	8	—	6	F	
	Fire Galley (new)	115W, 40G	200	24	—	1	F	+5 damage from Ballista, Helepolis. +10 damage from other siege weapons.
	Trireme	135W	200	12	—	7	F	Fire rate once/2 sec.
	Catapult Trireme	135W, 75G	120	35	—	9	F	Fire rate once/5 sec; small damage area.
	Juggernaut	135W, 75G	200	35	—	10	F	Fire rate once/5 sec; medium damage area.
BUILDINGS	Watch Tower	150S	100	3	—	5	—	Fire rate once/1.5 sec.
	Sentry Tower	150S	150	4	—	6	—	Fire rate once/1.5 sec.
	Guard Tower	150S	200	6	—	7	—	Fire rate once/1.5 sec.
	Ballista Tower	150S	200	20	—	7	—	Fire rate once/3 sec.

*All boats twice as resistant to conversion as other units.*

# Ancient Choson

- : Long Swordsman and Legion +80 hit points.
- : Towers +2 range.
- : Priests cost 30% less.

## Stone Age

## Tool Age

## Bronze Age

## Iron Age

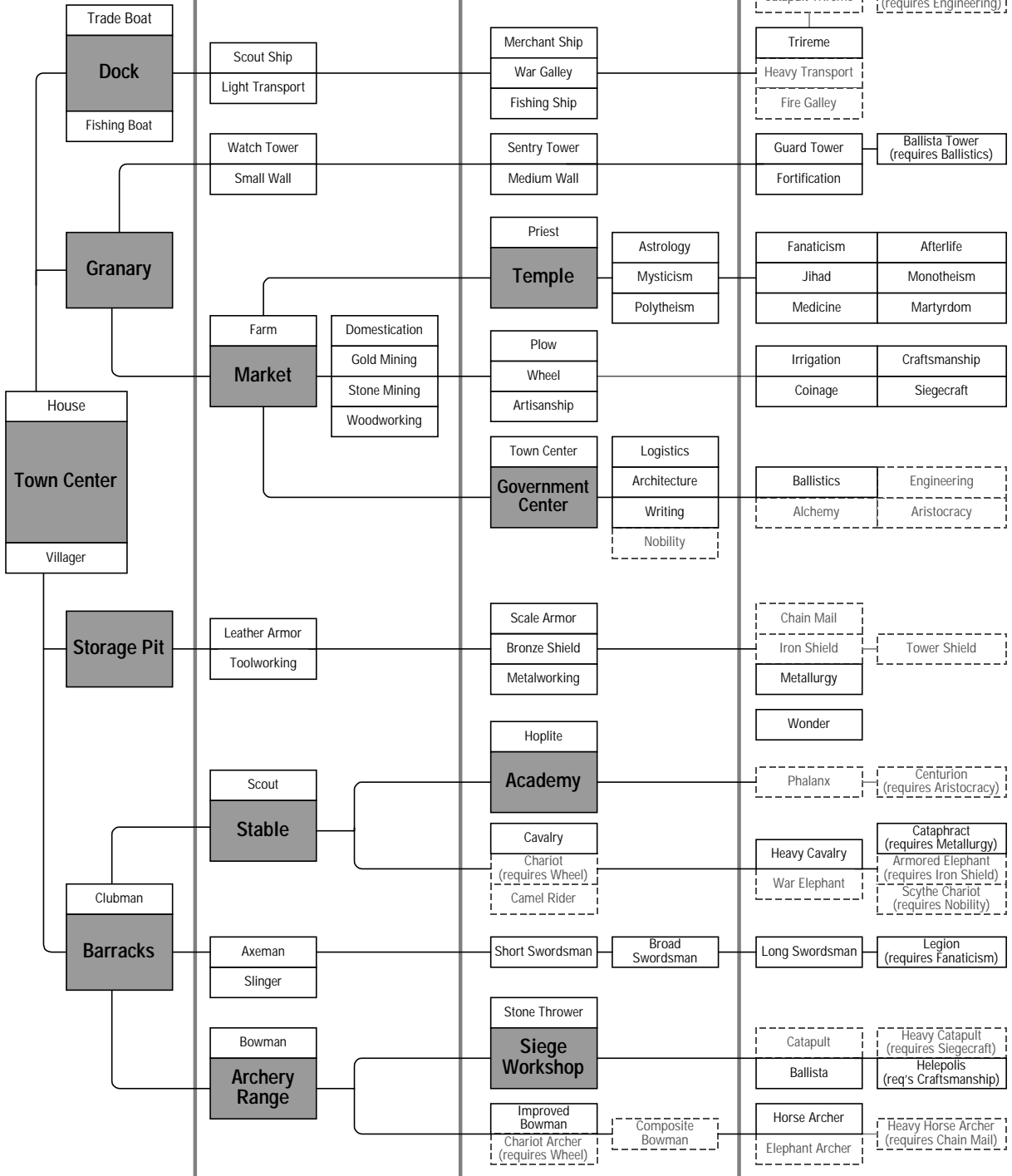

# Assyrian

- Archery Range units have increased fire rate. (Value in game remains the same as Age of Empires 1.0; changes occurred after the original documentation was printed.)
- Villagers 30% faster.

## Stone Age

## Tool Age

## Bronze Age

## Iron Age

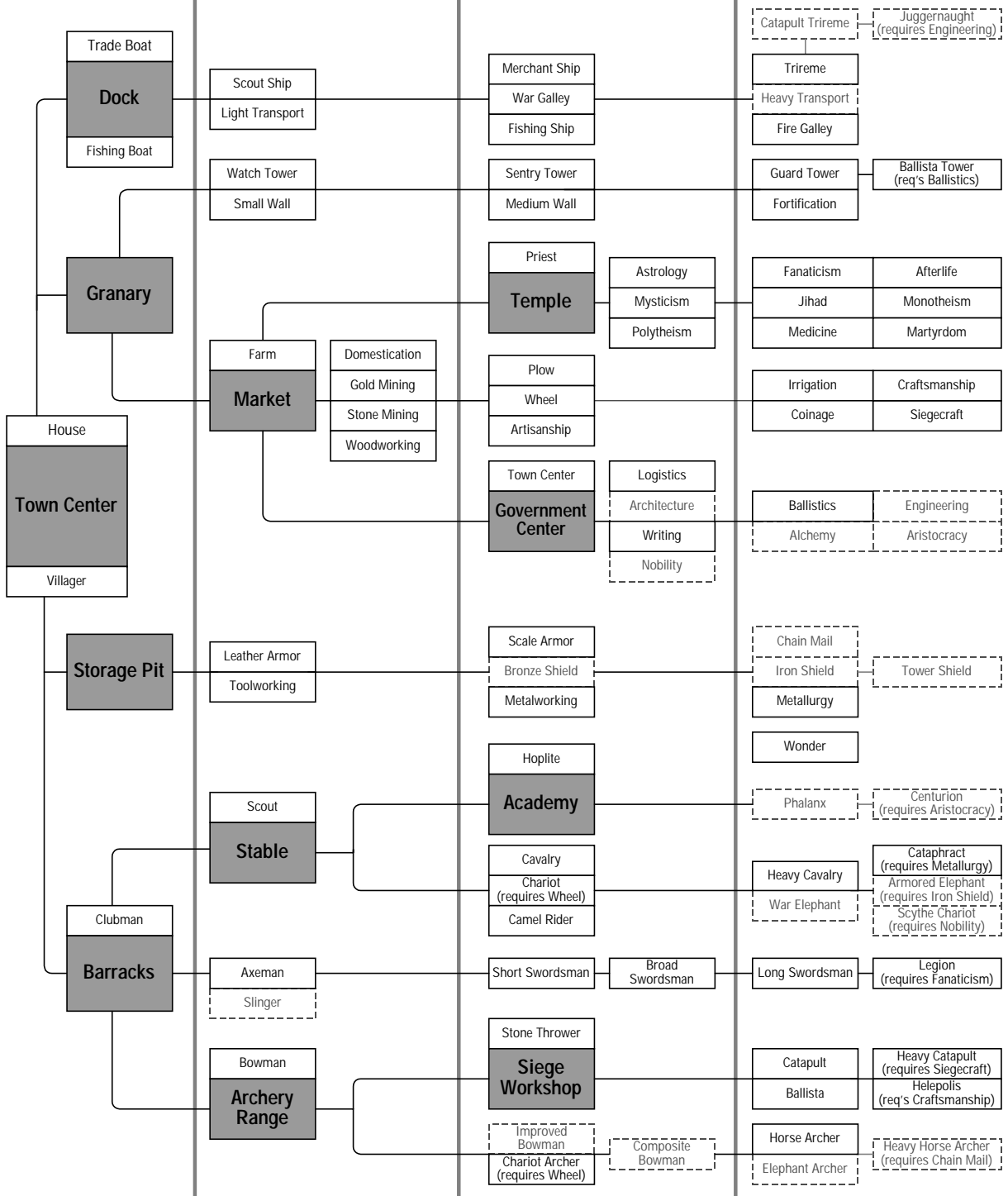

# Babylonian

- : Wall and tower hit points doubled.
- : Priest rejuvenation rate 30% faster.
- : +30% stone mining.

## Stone Age

## Tool Age

## Bronze Age

## Iron Age

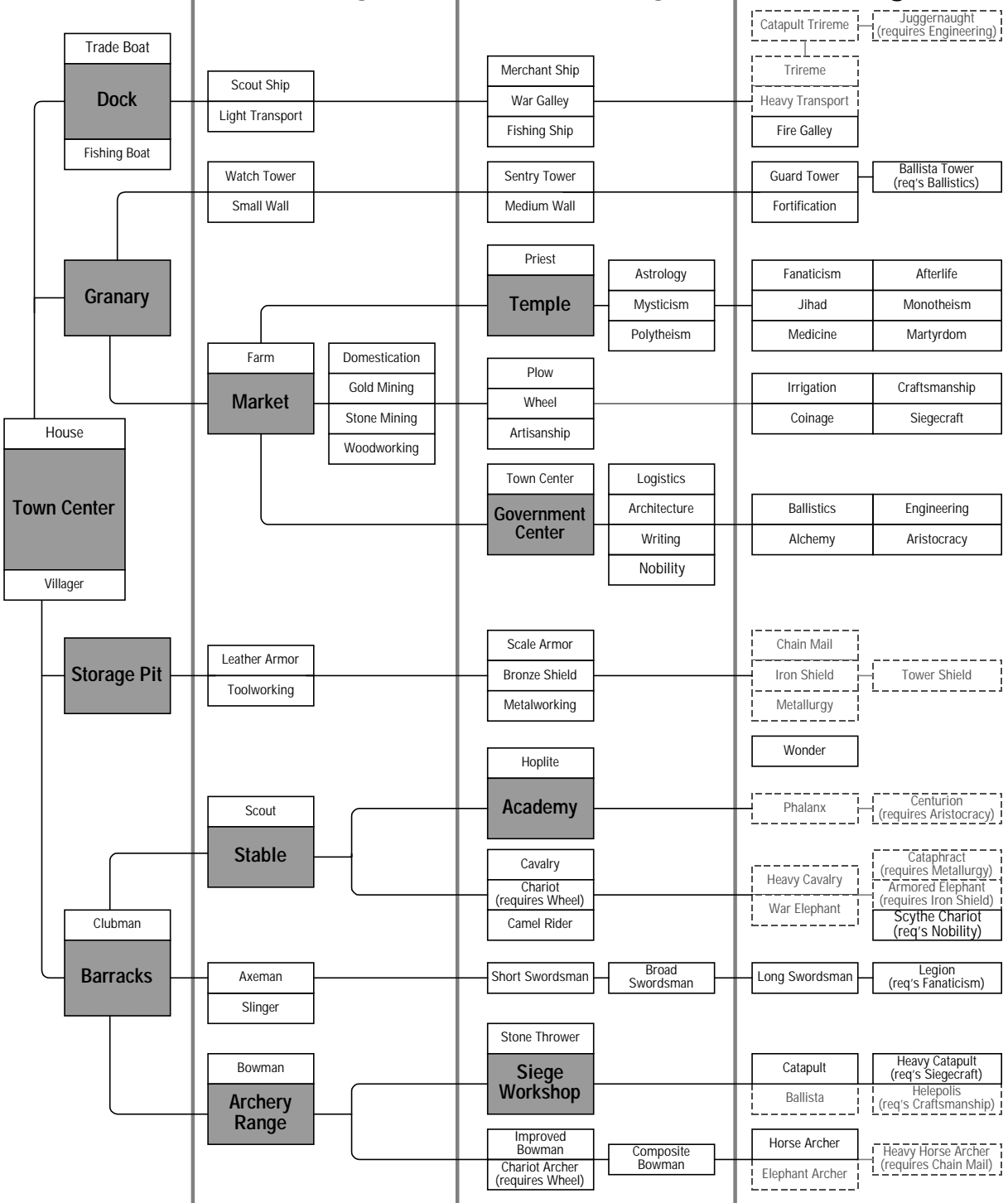



# Egyptian

- +20% gold mining.
- Chariot, Scythe Chariot, and Chariot Archer +33% hit points.
- Priest +3 range.

## Stone Age

## Tool Age

## Bronze Age

## Iron Age

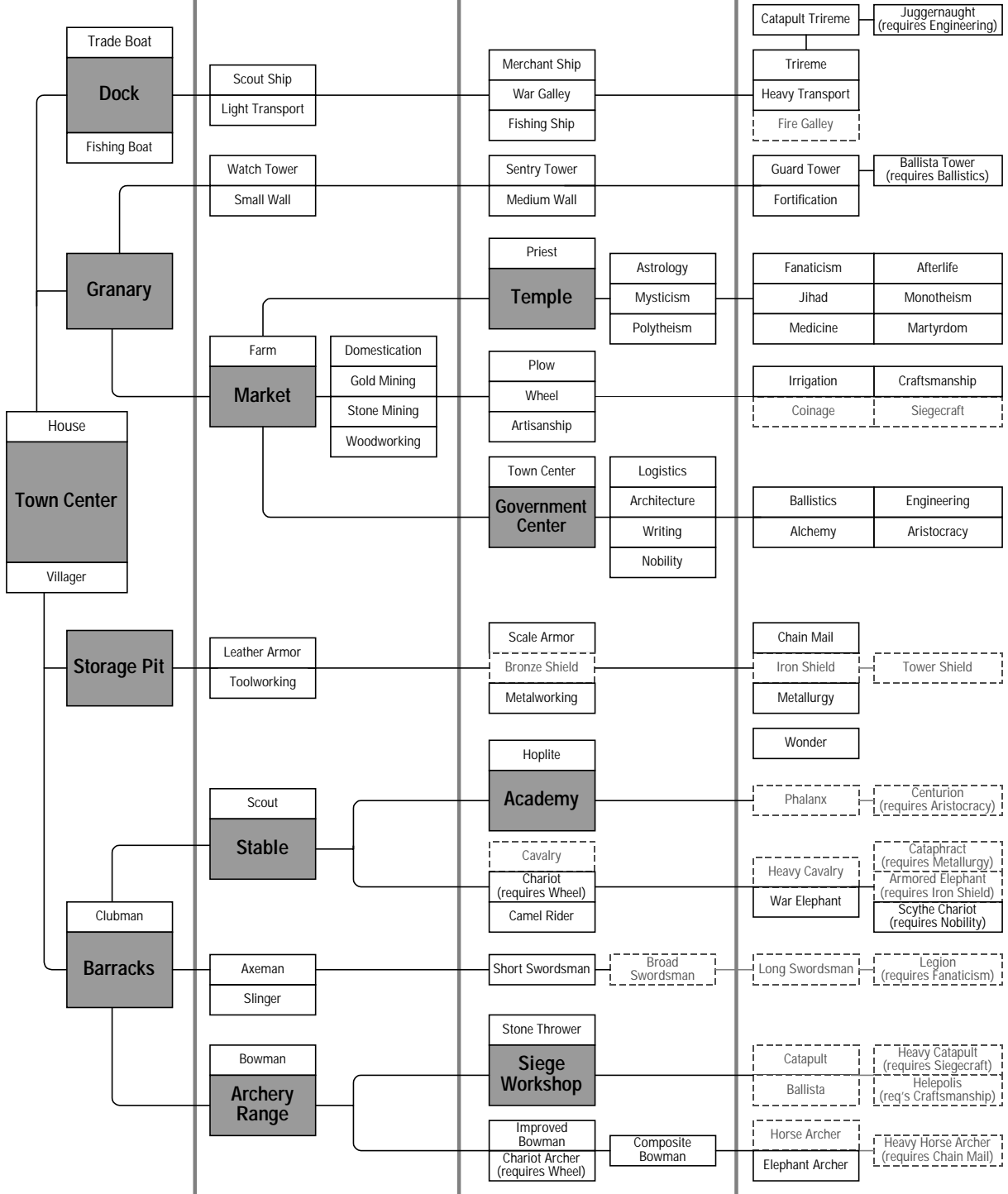

# Greek

- : Hoplite, Phalanx, and Centurion 30% faster.
- : War ships 30% faster.

## Stone Age

## Tool Age

## Bronze Age

## Iron Age

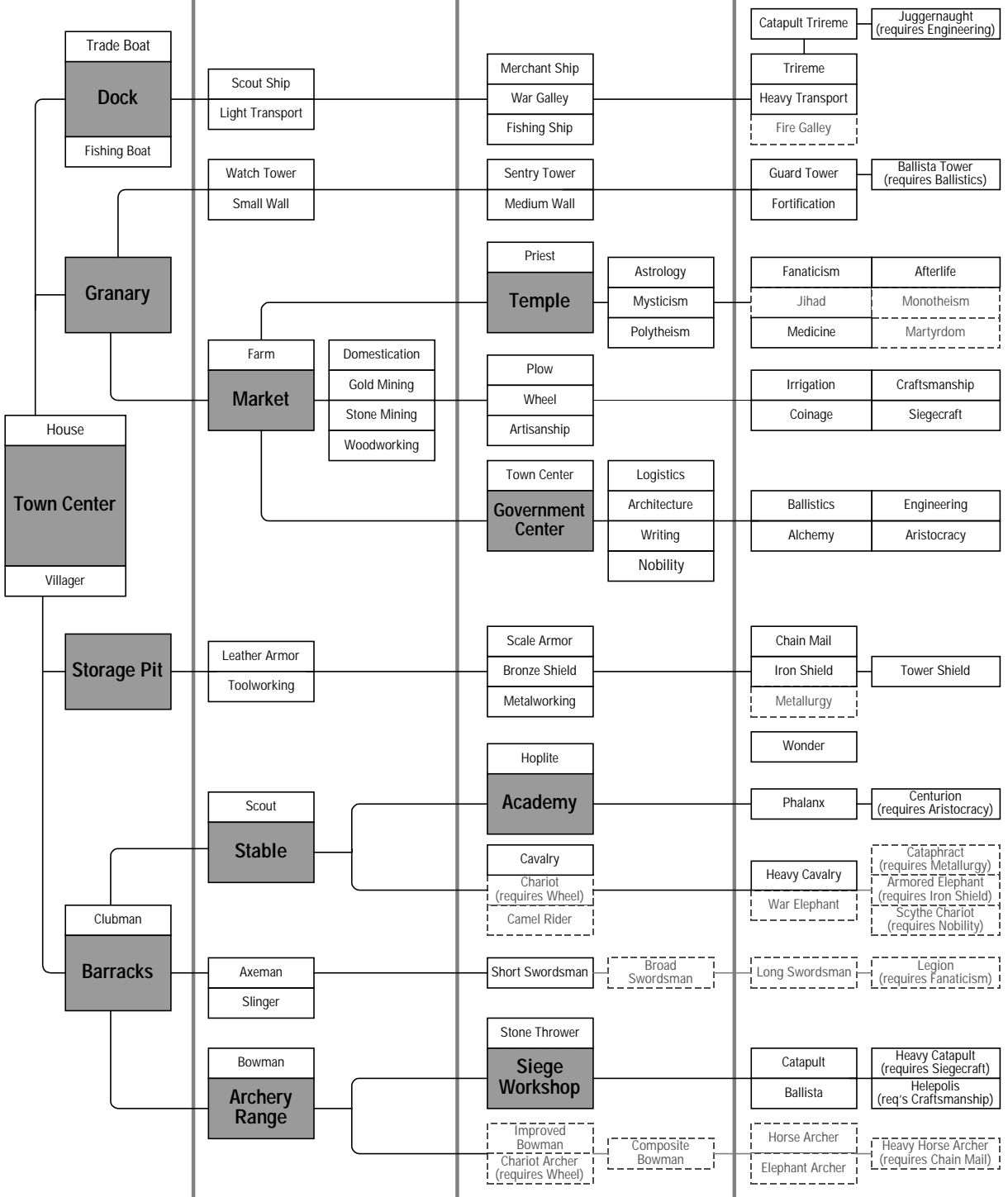

# Hittite

- Stone Thrower, Catapult, and Heavy Catapult hit points doubled.
- Archery Range units +1 attack.
- War ships +4 range (except Fire Galley).

## Stone Age

## Tool Age

## Bronze Age

## Iron Age

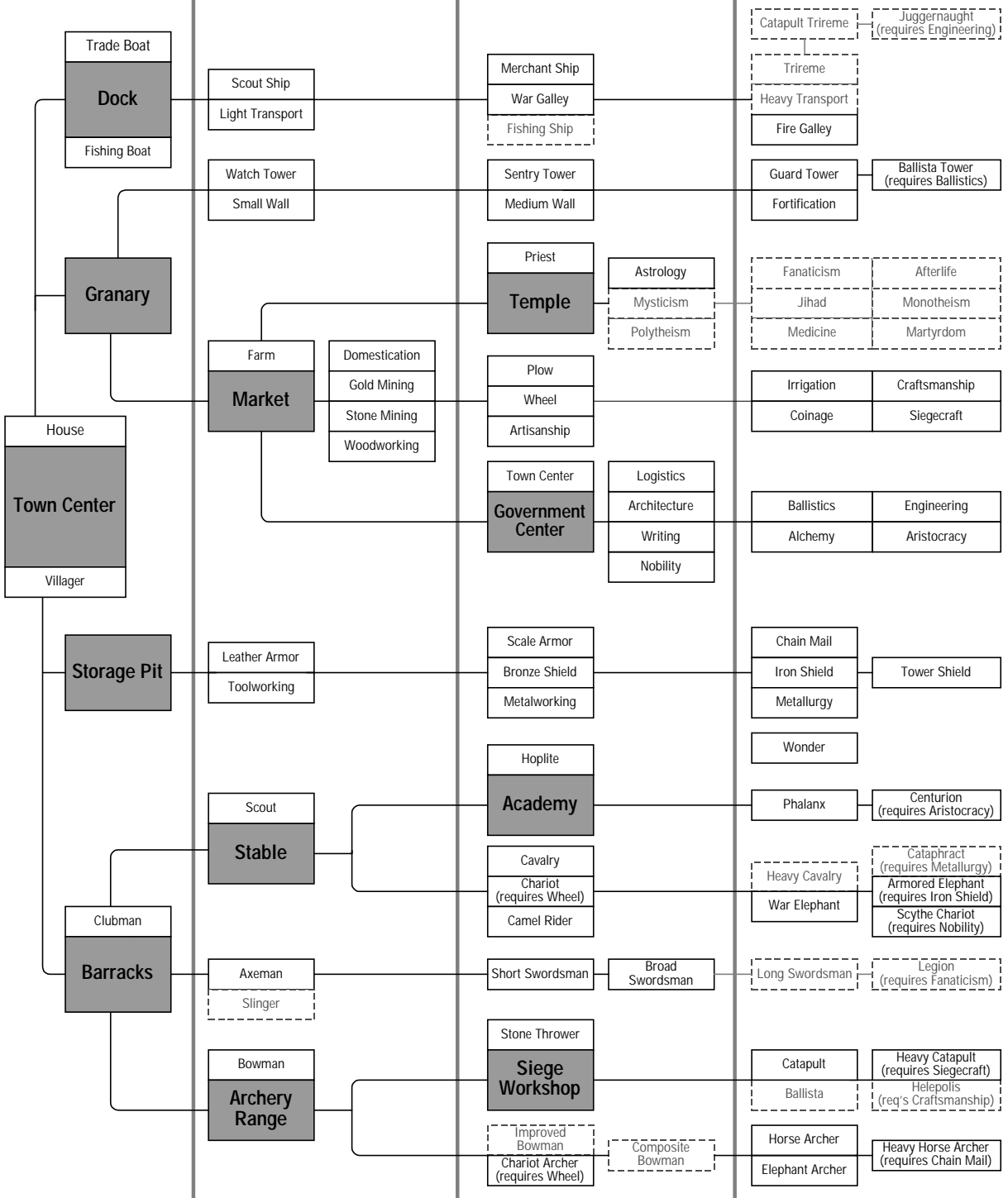



# Macedonian

- Academy units +2 armor vs. Slinger, Ballista, Helepolis, missile weapons.
- Units with no range +2 line of sight.
- Siege Workshop units cost 50% less.
- Units 4 times more resistant to conversion.

## Stone Age

## Tool Age

## Bronze Age

## Iron Age

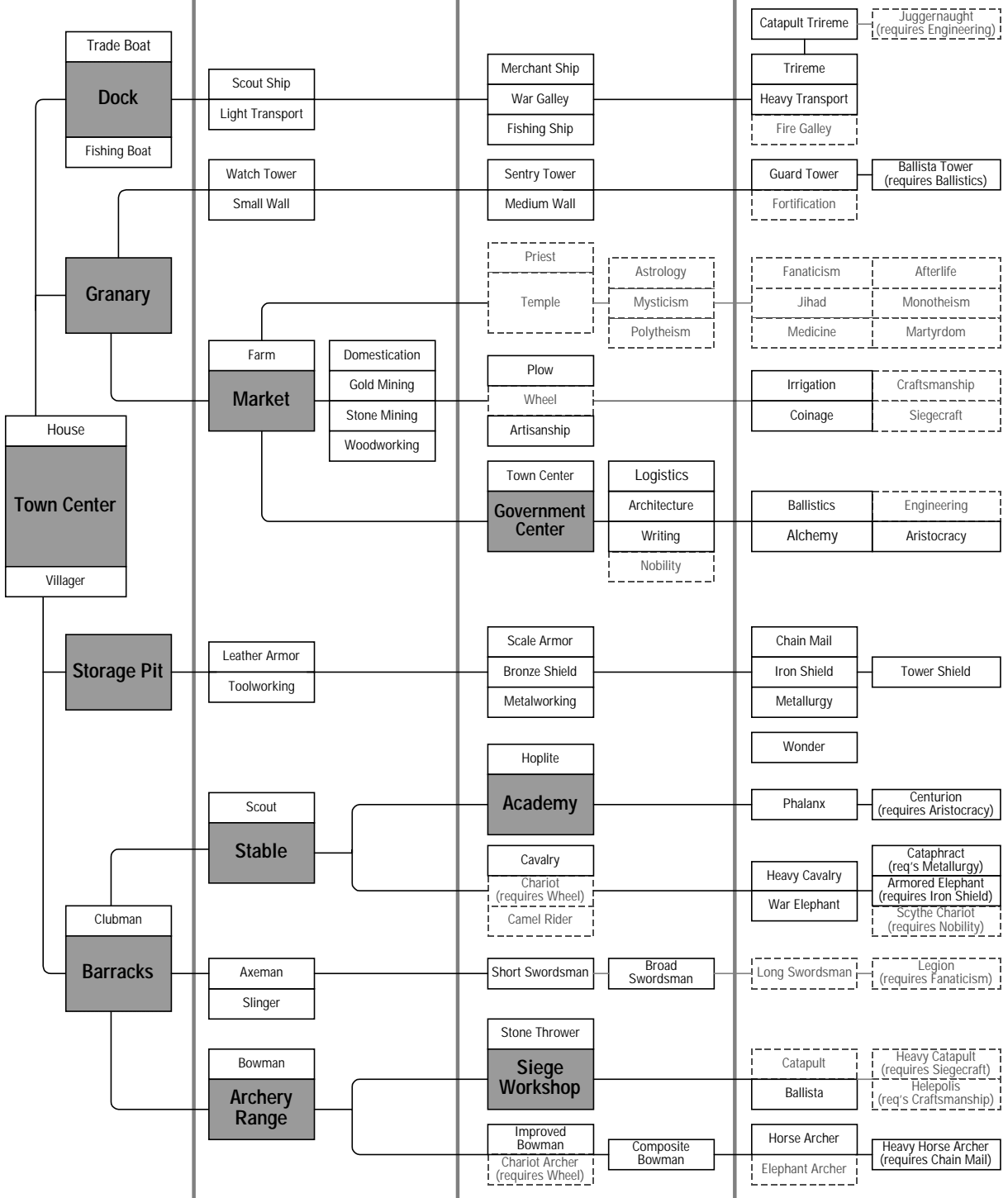

# Minoan

- Ships cost 30% less.
- Composite Bowman +2 range.
- Farm production +25%.

## Stone Age

## Tool Age

## Bronze Age

## Iron Age

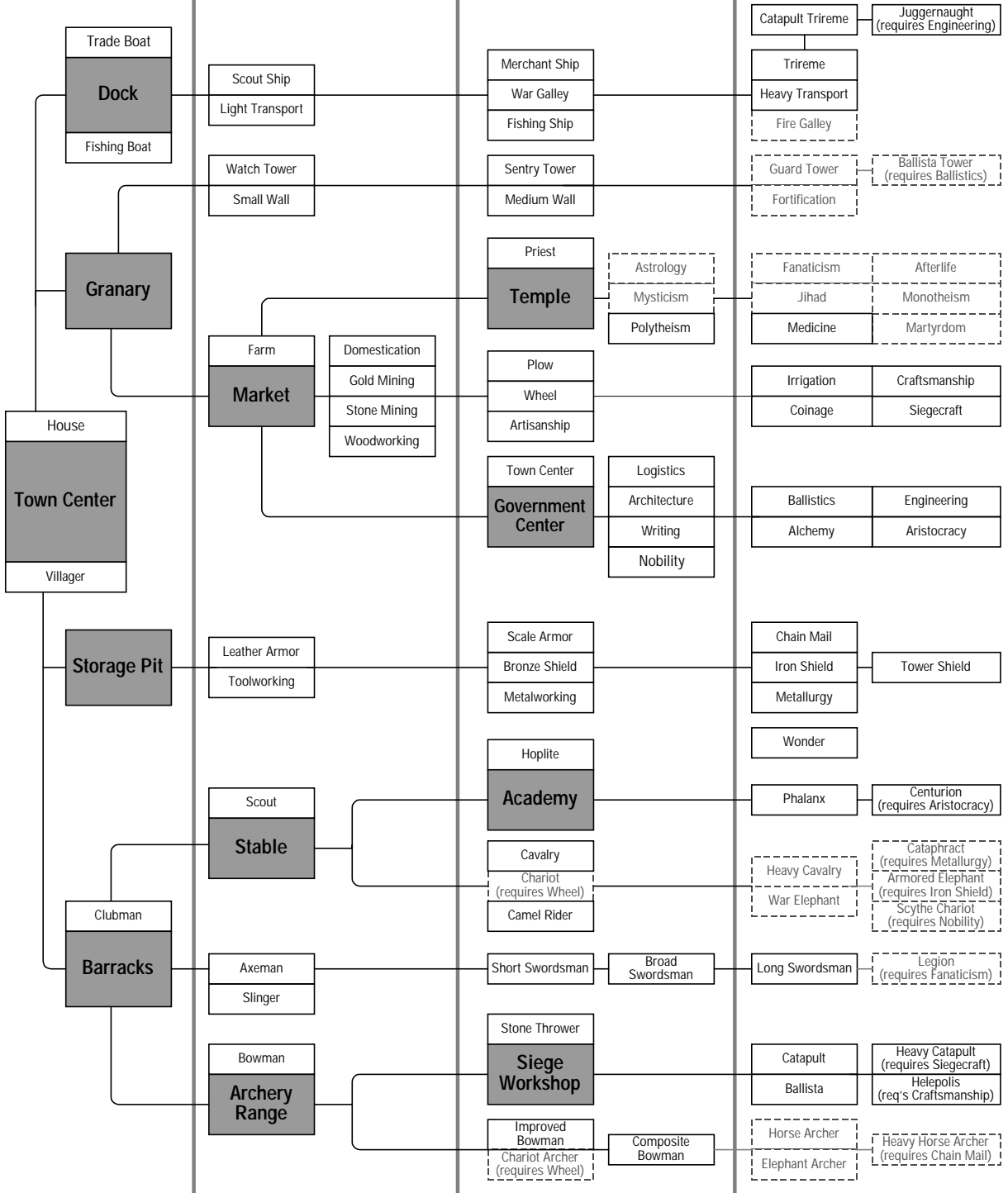

# Palmyran

- Free tribute.
- Gold per trade trip doubled.
- Villagers cost 50% more, have armor, and work 20% faster.
- Camel Riders 25% faster.

## Stone Age

## Tool Age

## Bronze Age

## Iron Age

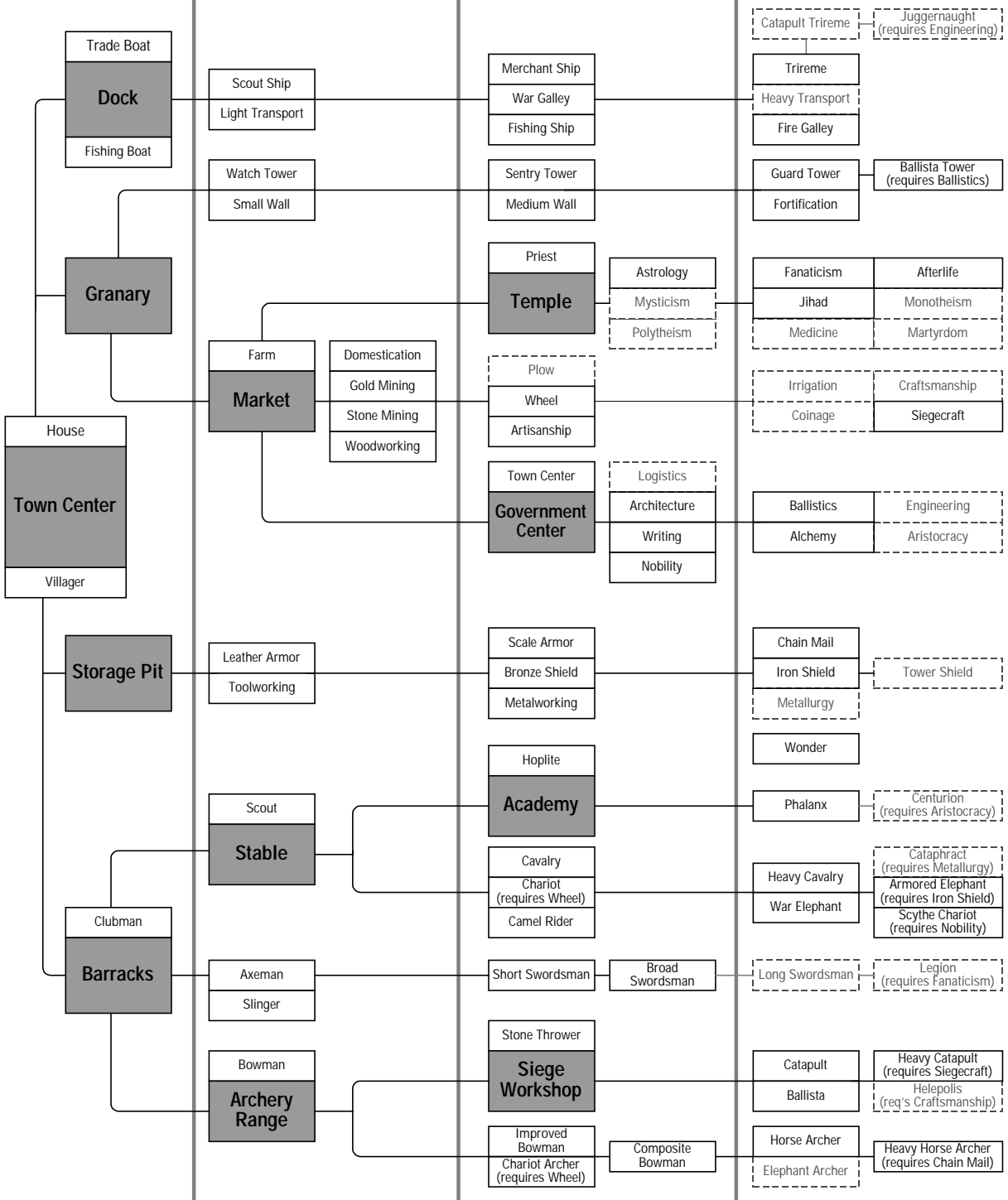

# Persian

- +30% hunting.
- War Elephant, Armored Elephant, and Elephant Archer 50% faster.
- Trireme +50% fire rate.

## Stone Age

## Tool Age

## Bronze Age

## Iron Age

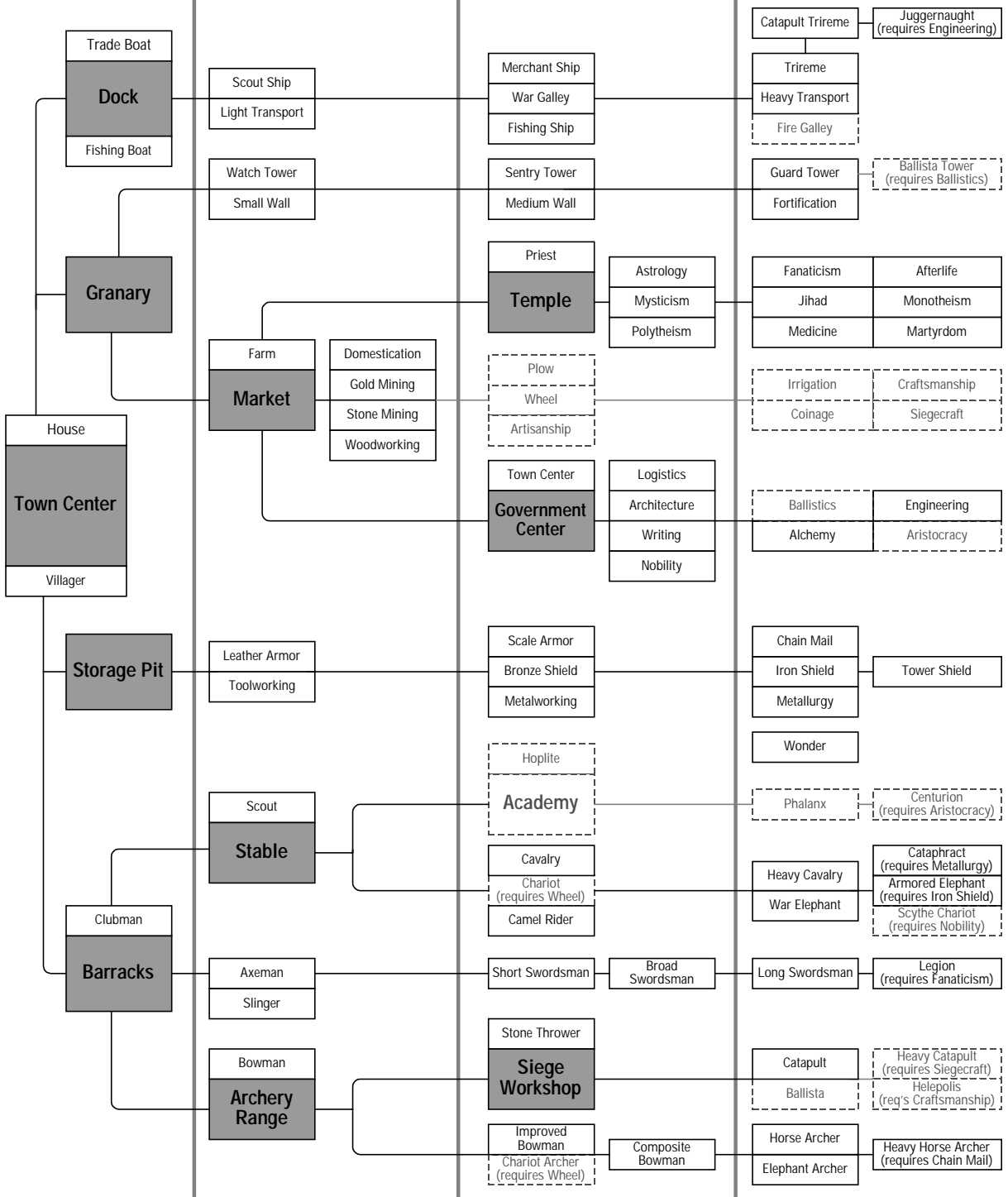



# Roman

- Buildings cost 15% less, except towers, walls and Wonders.
- Towers cost 50% less.
- Swordsmen attack 33% faster.

## Stone Age

## Tool Age

## Bronze Age

## Iron Age

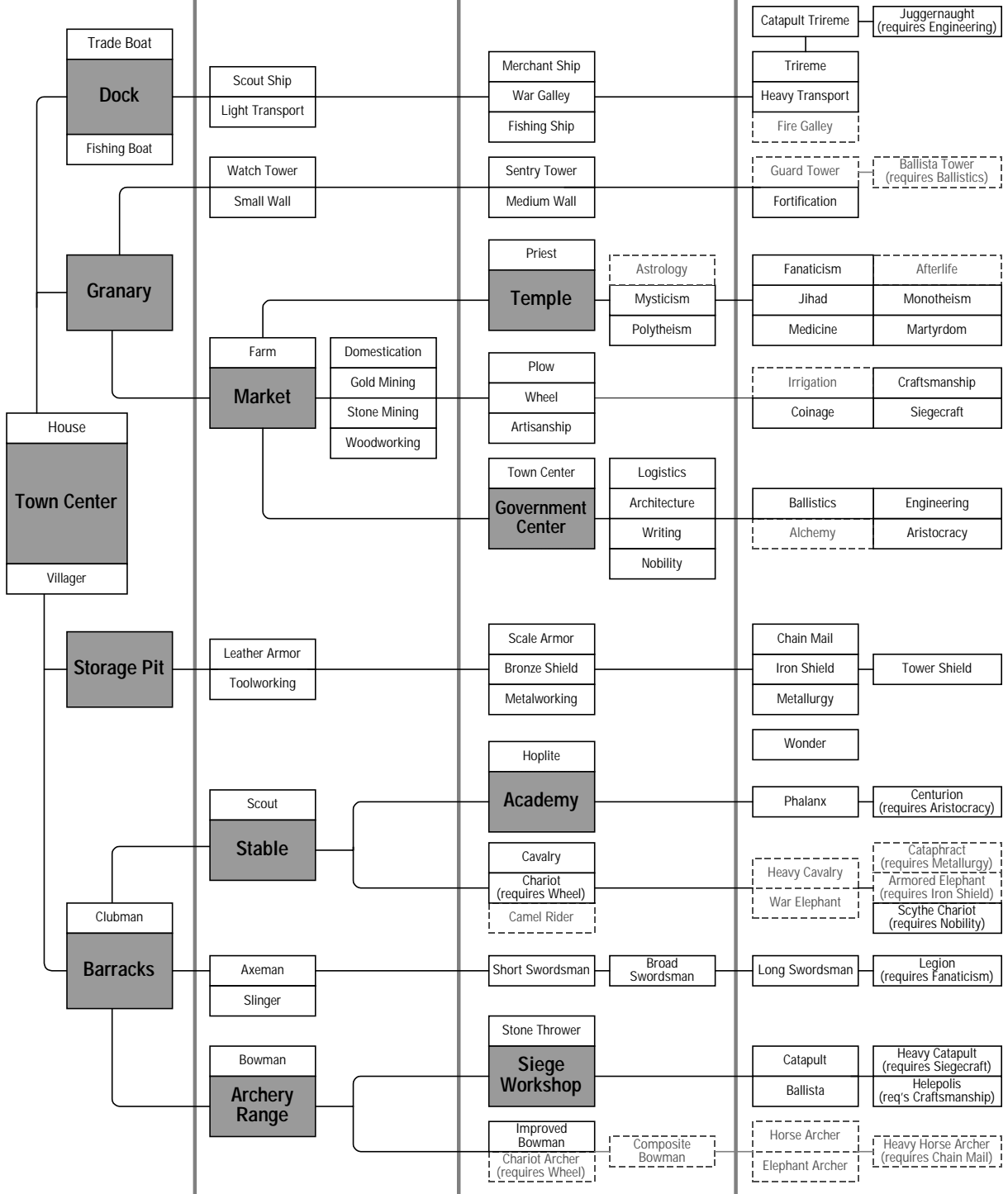

# Shang

- : Villagers cost 30% less.
- : Wall hit points doubled.

## Stone Age

## Tool Age

## Bronze Age

## Iron Age

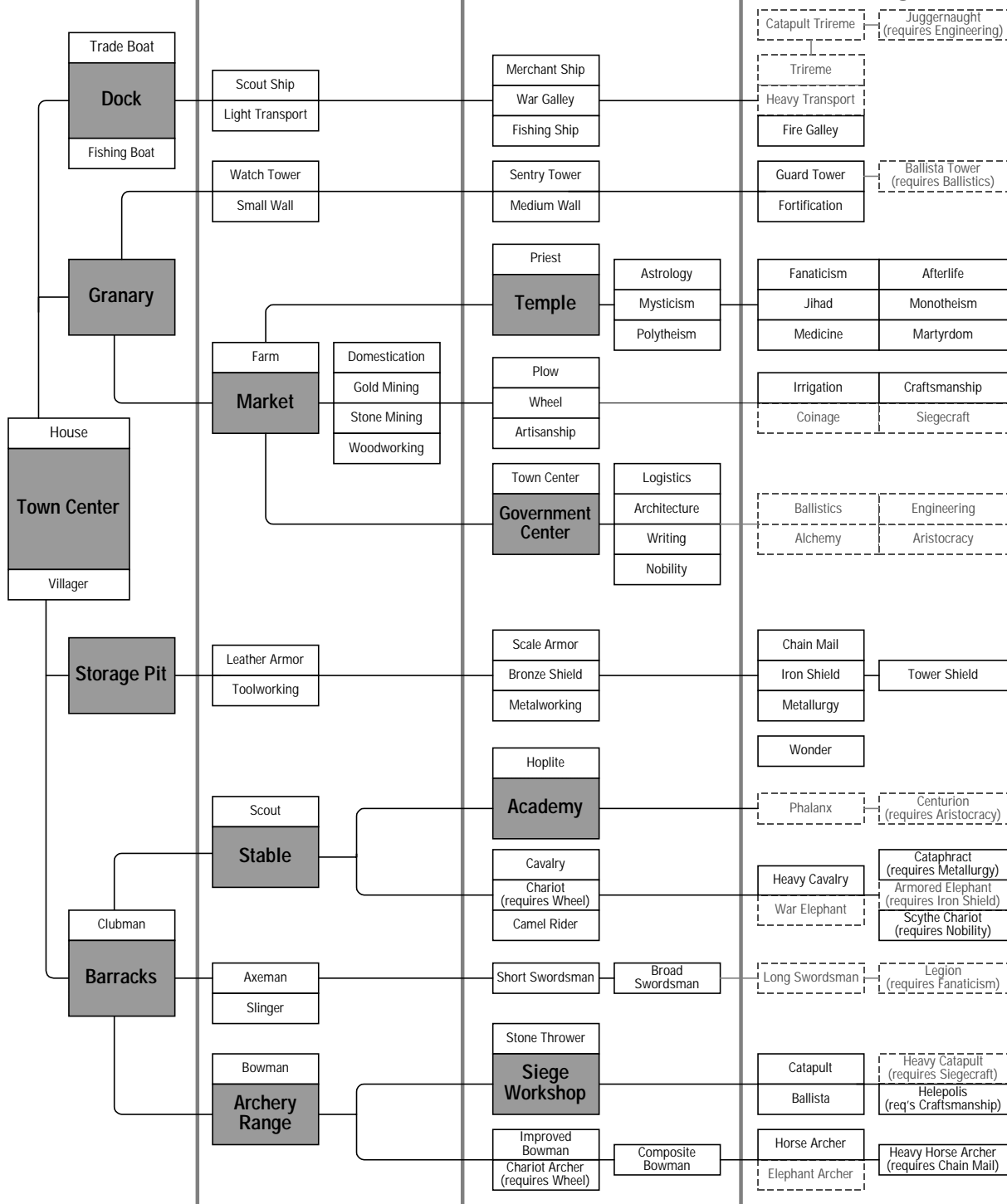

# Sumerian

- Villagers +15 hit points.
- Stone Thrower, Catapult, Heavy Catapult +50% fire rate.
- Farm production doubled.

## Stone Age

## Tool Age

## Bronze Age

## Iron Age

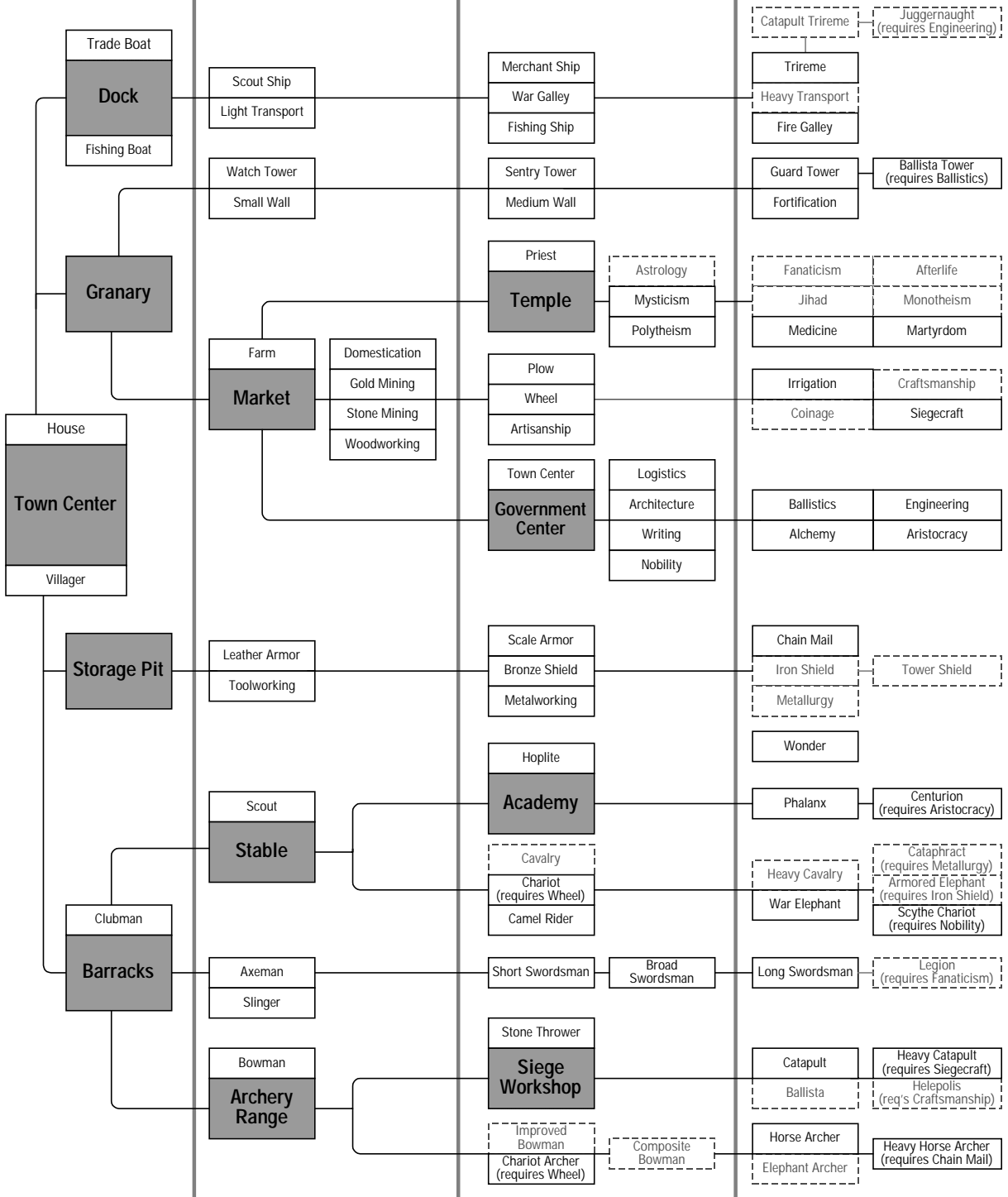



# Yamato

- Horse archers, Scout, Cavalry, Heavy Cavalry, Cataphract cost 25% less.
- Villagers 30% faster.
- Ships +30% hit points.

## Stone Age

## Tool Age

## Bronze Age

## Iron Age

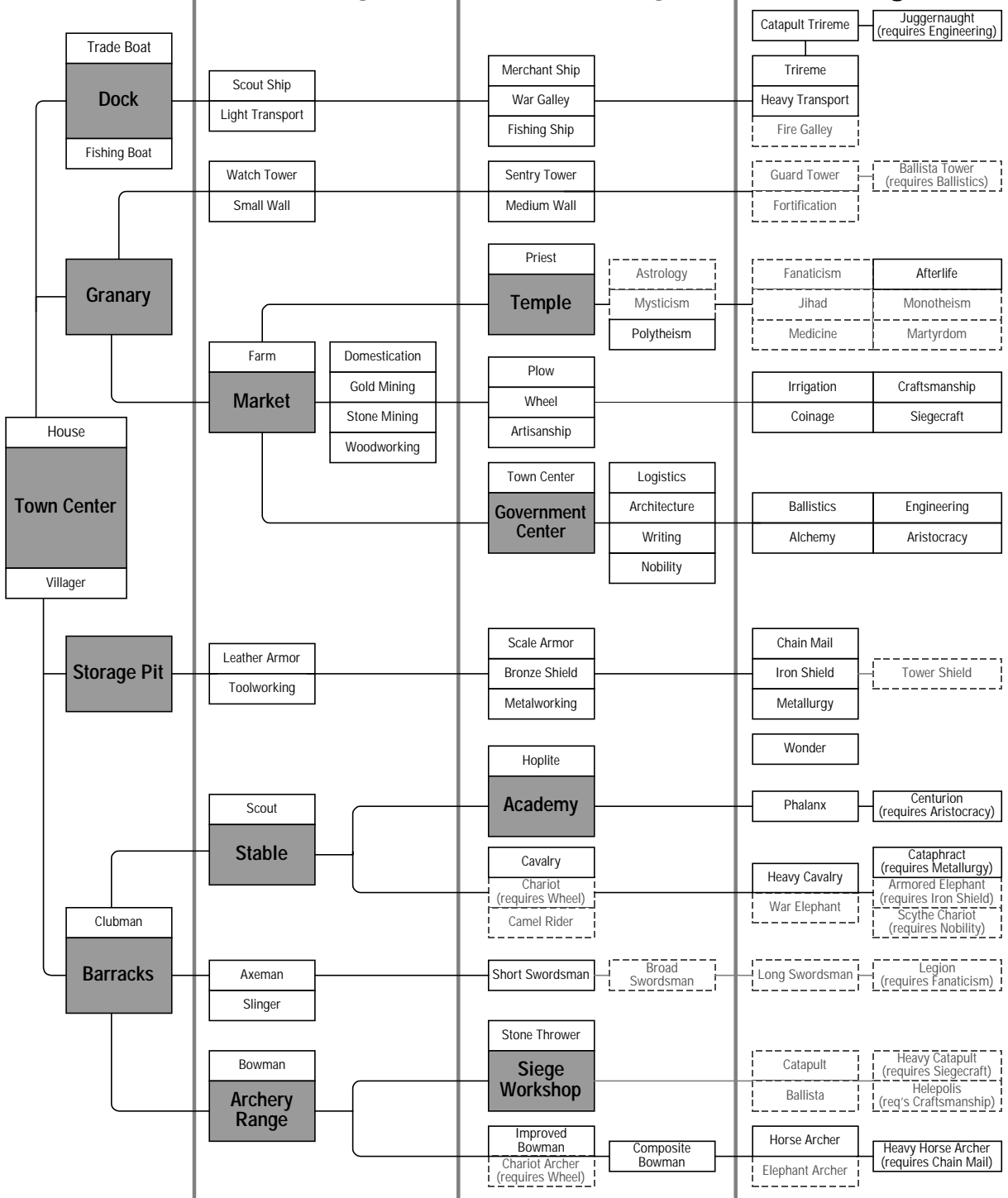

Information in this document is subject to change without notice. The names of companies, products, people, characters and/or data mentioned herein are fictitious unless otherwise noted. Complying with all applicable copyright laws is the responsibility of the user. No part of this document may be reproduced or transmitted in any form or by any means, electronic or mechanical, for any purpose, without the express written permission of Microsoft Corporation. If, however, your only means of access is electronic, permission to print one copy is hereby granted.

Microsoft may have patents, patent applications, trademarks, copyrights, or other intellectual property rights covering subject matter in this document. Except as expressly provided in any written license agreement from Microsoft, the furnishing of this document does not give you any license to these patents, trademarks, copyrights, or other intellectual property.

© & ® 1997 - 1998 Microsoft Corporation. All rights reserved.

Microsoft, MS, Age of Empires, DirectDraw, DirectPlay, DirectSound, DirectX, Windows, Windows NT and the Windows logo are either registered trademarks or trademarks of Microsoft Corporation in the US and/or other countries.

Developed by Ensemble Studios Corp. for Microsoft Corporation.

Genie engine technology © Copyright 1995, 1996, 1997, 1998 by Ensemble Studios Corp. All rights reserved.

Civilization maps in Age of Empires Expansion based on maps from Microsoft Encarta Virtual Globe 1995-1997, © & ® Microsoft Corporation. All rights reserved for Age of Empires Expansion.

Erich Lessing/Art Resource, NY: *Leonidas at Thermopylae* by Jacques Louis-David, 1815.

Other product and company names mentioned herein may be the trademarks of their respective owners.

## Microsoft Product Support Services

**Support Online:** To easily diagnose and answer technical questions yourself, visit <http://support.microsoft.com/support>.

**Standard No-Charge Support:** Monday to Friday, excluding holidays, Microsoft offers unlimited no-charge support for this product. In the U.S., call (425) 637-9308, 6:00 A.M. to 6:00 P.M. Pacific time. In Canada, call (905) 568-3503, 8:00 A.M. to 8:00 P.M. eastern time. Toll-charges may apply.

**Pay-Per-Incident Support:** In the U.S., for a fee of \$15US per incident, call (800) 936-5600 24 hours a day, seven days a week. In Canada, for a fee of \$45CDN plus tax per incident, call (800) 668-7975, 8:00 A.M. to 8:00 P.M. eastern time, Monday to Friday, excluding holidays. Support fees are billed to your VISA, MasterCard, or American Express card.

**Text Telephone:** For the deaf or hard-of-hearing using a TTY/TDD modem. In the U.S., (425) 635-4948. In Canada, (905) 568-9641.

**Additional Technical Support Information:** For support information outside the U.S. or Canada, or for additional Technical Support resources, see the Technical Support topic in the Help file.

*Support services and prices listed here are available in the United States and Canada only and are subject to Microsoft's then-current prices, terms, and conditions, which are subject to change without notice.*

# Age of Empires Expansion Credits

## Ensemble Studios

### Design

Sandy Petersen

### Programming

Tim Deen - Lead

Angelo Laudon

Dave Pottinger

Matt Pritchard

Paul Bettner

### Art

Scott Winsett - Lead

Duane Santos

Duncan McKissick

Herb Ellwood

Thonny Namuonglo

### Sound

Chris Rippy - Lead

### Music

Stephen Rippy - Lead

David Rippy

### Administration

Nellie Sherman

### Business

Bob Wallace

Brian Moon

### Production

Harter Ryan - Lead

Brian Sullivan

Tony Goodman

### Scenarios

Bruce Shelley

Chris Rippy

Greg Street

### Quality Assurance and Playtesting

Chris Campbell - Lead

Chea O'Neill, Chris Van

Doren, Don Gagen, David

Lewis, Ian Fischer, John

Evanson, Mark Terrano,

Mario Grimani, Sean Wolff

Trey Taylor

### Web Support

Mike McCart

## Microsoft

### Program Management

Tim Znamenacek

Ian Buck

### Product Planner

Edward Ventura

### Product Manager

Chris Di Cesare

### Technical Support Lead

Steve Kastner

### Test Leads

James Evans

Mark Thomas

### Testers

Jason Brown

Carl Bystrom

Francis Crick

Jeremy Hill

Andy Kriger

James Mayo

Josie Nutter

Eric Spunaugle

Luis Barriga

Recon Test Team

### Hardware Configuration

Team

Paul Gradwohl

Harold Ryan

### Playtest Team

Darin Boe

Robert Howg

Paul Skavland

Juan-Lee Pang

### Japanese Localization

Tester: Chris Ganje

### Beta Coordinator

Matt Alderman

### User Education Writer

Kelly Bell

### Historical Text Writer

Bruce Shelley

### Editor

Amy Robison

### Setup Art Designer

Connie Braat

### Print Designer

JoAnne Williams

### Localization Managers

Laurence K. Smith

Peter Connelly

Paul Delany

Yuko Yoshida

### Setup Development

Rich Eizenhoefer

Chris Haddan

### Art Director

Douglas Herring

### Legal

Jeff Koontz

### Management

Jo Tyo

Stuart Moulder

Alan Hartman

Edward Ventura

Matt Gradwohl

Craig Henry